

8378527

Recorded at the request of
Kern River Gas Transmission Company

When Recorded Mail to:
Kern River Gas Transmission Company
3683 West 2270 South, Suite C
Salt Lake City, UT 84120
Attn: Cynthia Lowrey

8378527
10/07/2002 03:44 PM 142.00
Book - 8661 Pg - 7634-7691
GARY W. OTT
RECORDER, SALT LAKE COUNTY, UTAH
KERN RIVER GAS TRANS CO
3683 W 2270 S STE C
SLC UT 84120
BY: SBN; DEPUTY - WI 58 P.

Salt Lake County

Assessor Parcel Nos. 14-01-200-005, 14-11-400-002, 14-23-400-022, 14-26-201-003,
14-26-201-004, 14-35-201-005, 14-35-252-009, 14-35-252-010, 14-35-405-017,
14-35-452-009, 20-02-200-010, 20-02-200-009, 20-02-253-027, 20-02-400-013,
20-02-400-008, 20-11-202-004, 20-11-400-007, 20-11-400-008, 20-11-400-011,
20-14-205-020, 20-14-205-023, 20-14-205-024, 20-14-451-003-4002,
20-23-200-004-4002, 20-23-200-004-4001, 20-14-451-003-4001, 20-23-400-001,
20-26-200-001, 20-35-400-002, 26-02-200-003, 26-02-400-001, 26-11-200-002, 26-11-
400-008-4001, 26-14-200-001, 26-14-400-004, 33-09-100-001, 33-09-151-003,
33-09-151-002, 33-09-326-002, 33-16-200-002, 33-16-200-004, 33-16-200-010,
33-16-200-022

**KERN RIVER GAS TRANSMISSION COMPANY
RIGHT-OF-WAY AND EASEMENT AGREEMENT**

This Right-of-Way and Easement Agreement (the "Easement") is entered into this
26 day of September 2002, by and between PacifiCorp, an Oregon
corporation, whose address is 1407 West North Temple, Salt Lake City, UT 84140
("Grantor") and Kern River Gas Transmission Company, a Texas general partnership and
wholly owned subsidiary of Mid American Energy Holding Company whose address is
295 Chipeta Way, Salt Lake City, UT 84108 ("Grantee").

RECITALS

A. By that certain Kern River Gas Transmission Company Right-of-Way and
Easement (the "Original Easement") dated the 9th day of September, 1991 and recorded
in the official records of the Salt Lake County Recorders Office September 12, 1991,
Entry Number 5125257, Book 6355, Page 1357, Utah Power & Light Company
("UP&L") conveyed to Kern River Gas Transmission Company ("Kern River") certain
rights in connection with Kern Rivers' installation and maintenance of a single natural
gas pipeline as set forth in the Original Easement over and across certain parcels of real

BK8661 PG7634

property located in Salt Lake, Utah and Millard Counties, State of Utah, as more particularly set forth and described in the Original Easement.

B. PacifiCorp, Grantor, is the successor in interest to UP&L by merger.

C. Grantee now desires to construct an additional 36" natural gas pipeline roughly parallel to the pipeline constructed in 1991. The location of the new additional pipeline is more particularly described or shown in Exhibits "A" through Exhibit "V" attached hereto and by this reference made a part of this Easement.

D. Grantor is willing to convey an Easement to Grantee for an additional pipeline provided that Grantee's operation, use and maintenance of the additional pipeline does not interfere with PacifiCorp's operation, use and maintenance of its existing and future transmission and distribution lines and appurtenances located upon the described parcels of real property. Grantor agrees that its use of the easement area will not interfere with Grantee's use and rights as provided herein.

NOW, THEREFORE, for the sum of Ten Dollars (\$10.00) and other good and valuable consideration and the mutual promises and covenants herein contained, the parties agrees as follows:

TERMS AND CONDITIONS

1. Conveyance of Easement.

1.1 Grant of Easement. Grantor hereby conveys to Grantee a non-exclusive right-of way and easement to locate, survey a route, construct, entrench, maintain, protect, inspect, repair, replace, remove, and operate one 36" natural gas pipeline, together with appurtenances, including but not limited to, valves, metering equipment, electrical cable, communications cable, and cathodic equipment and a single fiber optic "backbone" communications cable (the "Facilities"), said easement and right-of-way widths are more particularly described in Exhibit "A".

1.2 Limitation of Warranties. Grantor represents that, to the best of its knowledge, it is the owner in fee simple of the land underlying the Easement, but Grantor does not represent that it has made a title review and makes no warranties concerning its ownership.

1.3 Encroachment Agreement. By separate document the parties have entered into an agreement (the "Encroachment Agreement") dated August 5, 2002, concerning the Facilities to be located within Grantor's fee owned land or within easements held by Grantor used in connection with Grantor's electric utility operations. The rights granted under this Easement are further defined and limited by the Encroachment Agreement. In the event of a conflict or contradiction between this

Easement and the Encroachment Agreement, the terms of the Encroachment Agreement shall govern.

1.4 Ingress and Egress. Grantee shall have a reasonable right of ingress and egress to and from, and access along, said Easement with the right to use existing roads (subject to the restrictions contained in the Encroachment Agreement) for the purpose of constructing, inspecting, repairing, protecting and maintaining the Facilities.

1.5 Right to Clear Vegetation. Grantee shall have the right to cut and keep clear, without payment of damages, all trees, brush, and other obstructions that may in Grantee's opinion endanger, hinder or conflict with Grantee's rights hereunder.

2. Construction.

2.1 Right to Construct Additional Pipeline. Grantee shall have the right to install one 36" natural gas pipeline within the Easement in that location described in Exhibit "A", provided, however, that the additional pipeline shall be buried to a depth of and maintained not less than 60 inches measured from the top of the pipeline to the average level of the original ground on the two sides of the ditch in which said pipeline is laid or at such additional depths as may be required by any federal, state, or local authority having jurisdiction.

2.2 Temporary Construction. During temporary period, Grantee may use such portions Grantor's land outside of the described Easement along and adjacent to the easement as may be reasonably necessary in connection with the construction, maintenance, repair, or removal of the Facilities; provided, however, that Grantor and Grantee shall enter into separate Temporary Construction Easements for use of Grantor's land outside of the described Easement.

2.3 Restoration. Prior to the construction of the Facilities, and for any and all construction or maintenance work thereafter, Grantee shall segregate all of the topsoil material from other landfill material removed or disturbed in the construction area and shall, within sixty (60) days from the date of completion of the work performed, refill all excavations made by Grantee, grade and replace the topsoil, reseed the area impacted by construction with native grass seed, install erosion control structures, or otherwise restore the land as near as reasonably possible to its pre-construction condition and to Grantor's satisfaction.

2.4 Interference with Grantor's Uses of its Land. Grantee shall use reasonable commercial efforts to limit the disturbance to Grantor, its lessees, licensee, and tenants during the construction or maintenance of its Facilities to the extent reasonably possible and shall comply with all reasonable requests by Grantor to limit or alter its construction work and timing of such construction and maintenance work to minimize the disturbance

to Grantor's use of its land. Grantee shall compensate Grantor, its lessees, licensees, and tenants for all damages to real and personal property caused by the construction, maintenance, repair, replacement or removal of the Facilities.

2.5 As-Built Drawings. Within one year following the completion of the construction of the pipeline, Grantee will complete and provide to Grantor at no cost an as-built survey of the Facilities and any other facilities and appurtenances constructed or located within the Easement.

3. Grantor's Reserved Rights. Grantor reserves the right to use and enjoy the Easement for its own purposes and to convey interests or grant privileges to third parties and without Grantee's consent; provided that any use made by third parties shall not unreasonably interfere with Grantee's rights hereunder and shall comply with safety and encroachment specifications as are standard in the natural gas pipeline industry or required by applicable law or regulation.

4. Abandonment.

4.1 Consent Required. Grantee may abandon and leave all or a portion of its Facilities in place and relinquish all right, title, and interest to such Facilities to Grantor. Grantee shall be deemed to have abandoned its use of the Facilities if such pipelines are not used for the actual transmission of natural gas for a period of five (5) consecutive years.

4.2 Release of Title. If Grantee abandons its Facilities in place as provided in section 4.1 above, Grantee shall execute and record a document of reconveyance and release whereupon this Easement and all rights and privileges herein granted shall be fully canceled and terminated.

5. Compliance with Law. Grantee shall observe and comply with all rules, regulations, and laws now in effect or which may hereafter be enacted during the continuance of this Easement by any governmental entity having jurisdiction over Grantee and its business as conducted upon Grantor's land.

6. Taxes. Grantee shall pay when due all taxes and assessments levied against its improvements built upon Grantor's land, all taxes on personal property brought upon Grantor's land and any taxes that may become due because of the conveyance of this Easement. Grantee shall indemnify and hold Grantor harmless from any liability for the payment of such taxes. Grantor shall continue to pay all real property taxes and assessments levied against Grantor's land not caused by Grantee's Facilities

thereon and shall indemnify and hold Grantee harmless from any and all liability for the payment of any such taxes and assessments.

7. Indemnification. Grantee shall protect, indemnify and hold harmless Grantor, its subsidiaries, and affiliates and its and their officers, directors, and employees (collectively "Indemnitees"), from and against any and all losses, claims, liens, demands, and causes of action of every kind and nature, including but not limited to the amount of any judgment, penalty, interest, court cost or legal fee incurred by the Indemnitees or any of them in the defense of same, arising in favor of any party, including governmental agencies or bodies, on account of taxes, claims, liens, debts, personal injuries, death, or damages to property, violations of Environmental Laws and Regulations, and all other claim or demands or every character arising directly or indirectly out of Grantee's ingress and egress to Grantor's property or Grantee's use of the Easement, provided that all of the indemnification and save harmless provisions of this Easement exclude any pro rata liability attributable to Grantor's negligence or resulting from acts creating strict liability of Grantor or caused by Grantor's breach of this Easement. This Paragraph shall survive the termination of the easement.

For purposes of this Easement, "Environmental Laws and Regulations" shall mean all present and future federal, state, and local laws and all rules and regulations promulgated hereunder, relating to pollution or protection of the environment.

8. Attorney's Fees and Costs. If any suit or action arising out of or related to this Easement is brought by any party, the prevailing party shall be entitled to recover the costs and fees, including without limitation, reasonable attorneys' fees, the fees and costs of experts and consultants, copying, courier and telecommunication costs, and deposition costs and all other costs of discovery, incurred by such party in such suit or action, including, without limitation, any post-trial or appellate proceeding, or in the collection or enforcement of any judgment or award entered or made in such suit or action.

9. Integration. It is mutually understood and agrees that this Easement as written covers and includes all of the agreements and stipulations between the parties and that no representations or statements, verbal or written, have been made modifying, adding to or changing the terms hereof.

10. Succession. This Easement shall run with the land and shall be binding upon and shall inure to the benefit of the successors, assigns, heirs, executors, and administrators of the parties.

11. Subject to Existing Rights. This Easement is made subject to any existing easements or rights-of-way or other interests of record and is made without any warranties or representations from Grantor, other than those expressly set forth herein.

12. Authorization. Each individual executing this Easement does thereby represent and warrant to each other so signing (and to each other entity for which another

person may be signing) that he or she had been duly authorized to sign this Easement in the capacity and for the entities set forth where he or she signs.

IN WITNESS WHEREOF, the parties hereto have executed this Amended and Restated Right-of-way and Easement Agreement on the date and year first above written.

DATED this 26 day of September 2002.

PACIFICORP, an Oregon
Corporation, d.b.a. Utah Power
& Light Company

By: *Ernest E. Williams*

Title: *Vice President*

ACCEPTED BY:

KERN RIVER GAS
TRANSMISSION COMPANY

By: *Richard E. Gull*

Title: *Attorney-in-Fact*

BK8661PG7639

ACKNOWLEDGMENTS

STATE OF UTAH)

COUNTY OF SALT LAKE)

On the 26th day of September, 2002, personally appeared before me, Ernest E. Wissman, who being by me duly sworn says that he/she is a Vice President, Utah Power & Light Company, an assumed business name of PacifiCorp, an Oregon corporation, that executed the above and foregoing instrument and that said instrument was signed in behalf of said corporation by authority of its by-laws (or by a resolution of its board of directors) and said Vice President acknowledged to me that said corporation executed the same.

IN WITNESS WHEREOF, I have herewith set my hand and affixed my seal this 26th day of September, 2002

My Commission Expires:

12/5/02

Melanie R. Allen
NOTARY PUBLIC

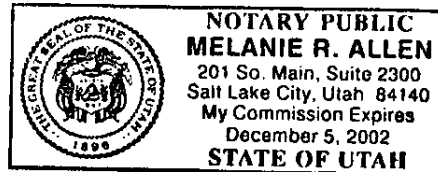

STATE OF Utah)

COUNTY OF Salt Lake)

On this 1st day of October, 2002, Richard E Huff, personally appeared before me and being by me duly sworn, did say that she/he is the Attorney-in-Fact of Kern River Gas Transmission Company, and that the Agreement was signed on behalf of Kern River Gas Transmission Company and said Richard E Huff acknowledged to me that she/he as such Attorney-in-Fact executed the same.

My Commission Expires:

12/12/05

Nadine Hauk
Notary Public

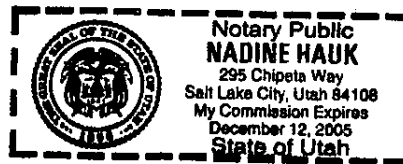

EXHIBIT "A"

UTAH POWER AND LIGHT COMPANY
SALT LAKE COUNTY, UTAH
L.L. No. K-UT-SL-137.241W
SHEET 1 OF 1

A TWENTY FIVE (25) FOOT WIDE PERMANENT EASEMENT

Being a twenty five (25) foot wide permanent easement lying twenty five (25) feet Northwesterly of the following described Survey line, also following an existing Kern River 36" pipeline.

Said twenty five (25) foot wide permanent easement extending over, through and across a portion of a certain tract conveyed to Utah Power and Light Company, and being located in a portion of the East Half of the East Half of the Northeast Quarter of Section 1, Township 1 South, Range 2 West, Salt Lake Base and Meridian, Salt Lake County, Utah. Said tract being more particularly described in Deed Book 4810, Page 128 and Deed Book 4611, Page 1377 of the Deed Records of Salt Lake County, Utah, said Survey line being more particularly described as follows:

Beginning at a point on the East line of said Section 1, from which a Standard Salt Lake County Brass Cap found marking the Northeast corner of said Section 1 bears North 00°00'44" West, a distance of 315.13 feet;

THENCE South 43°30'15" West, a distance of 441.36 feet to the point of terminus on the West line of said tract, from which an Iron Rod with Cap found marking the Northwest corner of said tract, bears North 03°14'16" East, a distance of 476.66 feet, said easement being 26.75 rods in length and contains 0.25 acres of land.

BK 866 | PG 764 |

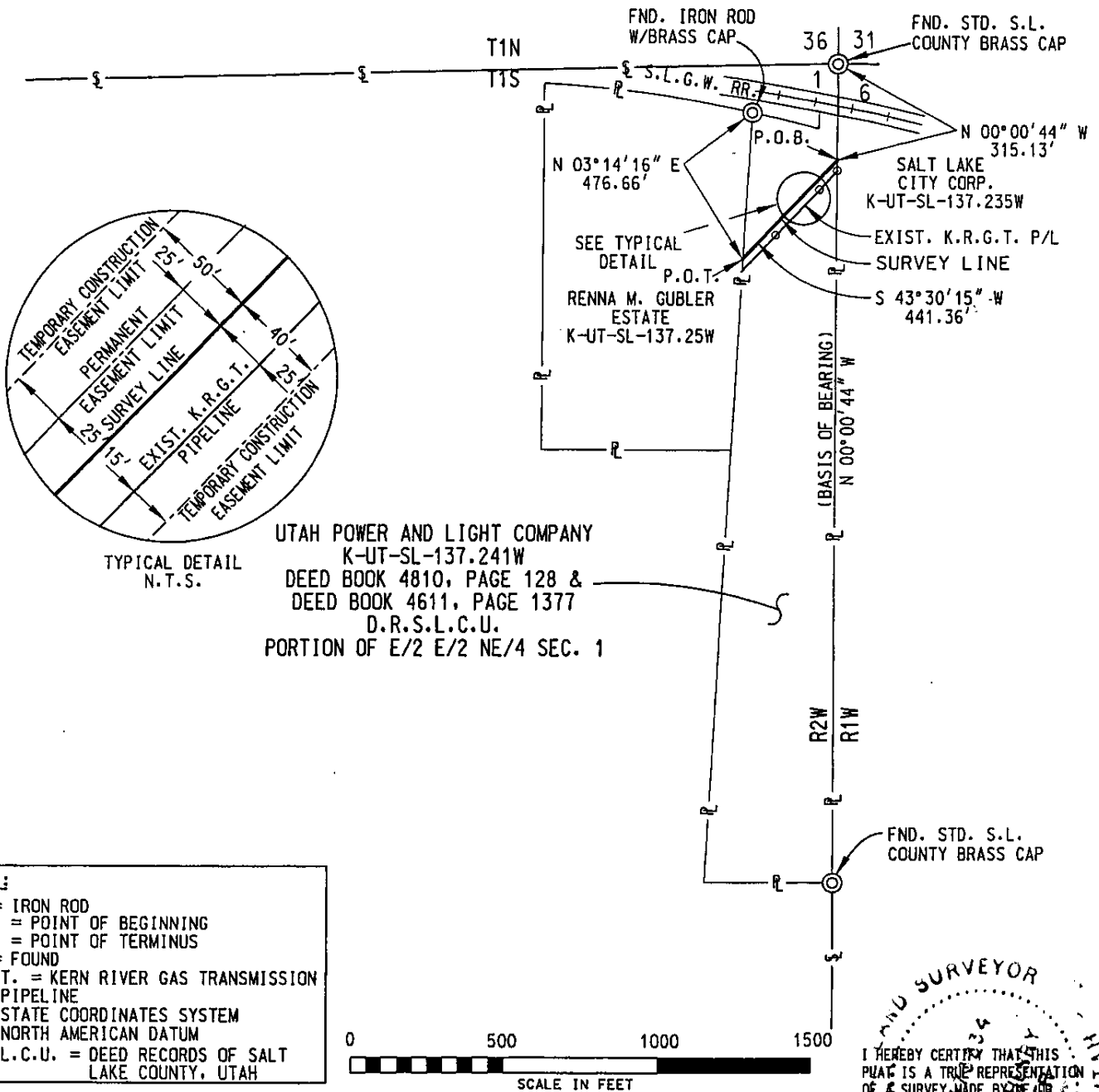

UTAH POWER AND LIGHT COMPANY
 K-UT-SL-137.241W
 DEED BOOK 4810, PAGE 128 &
 DEED BOOK 4611, PAGE 1377
 D.R.S.L.C.U.
 PORTION OF E/2 E/2 NE/4 SEC. 1

LEGEND:
 I.R. = IRON ROD
 P.O.B. = POINT OF BEGINNING
 P.O.T. = POINT OF TERMINUS
 FND. = FOUND
 K.R.G.T. = KERN RIVER GAS TRANSMISSION
 P/L = PIPELINE
 SPC = STATE COORDINATES SYSTEM
 NAD = NORTH AMERICAN DATUM
 D.R.S.L.C.U. = DEED RECORDS OF SALT LAKE COUNTY, UTAH

- NOTES:**
1. BEARINGS AND DISTANCES ARE BASED ON THE "UTAH COORDINATE SYSTEM 1983 CENTRAL ZONE", DERIVED FROM GPS METHODS. SCALE FACTOR OF 0.999742630 APPLIED TO RODDAGE AND ACREAGE.
 2. BASIS OF BEARING EAST LINE OF SECTION 1 BEING N 00°00'44" W
 3. EASEMENT SURVEY AUGUST 2001.
 4. PREPARED BY: UNIVERSAL ENSCO, INC. 1811 BERING DR. HOUSTON, TX. 77057

LAND SURVEYOR
 I HEREBY CERTIFY THAT THIS PLAT IS A TRUE REPRESENTATION OF A SURVEY MADE BY ME OR UNDER MY DIRECT SUPERVISION.
 GARY HENRY GIBER PLS #373234
 PROFESSIONAL LAND SURVEYOR

DRAWING NO.		REFERENCE TITLE		KERN RIVER GAS TRANSMISSION COMPANY PROPERTY PLAT PERMANENT, TEMPORARY CONST. & A.T.W.S. EASEMENTS CROSSING PROPERTY OF UTAH POWER AND LIGHT COMPANY T. 1 S - R 2 W, SECTION 1 SALT LAKE COUNTY, UTAH						
NO.	DATE	BY	REVISION DESCRIPTION	W.O. NO.	CHK.	APP.	DRAWN BY: UEI	DATE: 03-29-2002	ISSUED FOR BID:	SCALE: 1" = 500'
1	8-22-2002	UEI	REVISE EASEMENTS				CHECKED BY: UEI	DATE: 03-29-2002	ISSUED FOR CONSTRUCTION:	
							APPROVED BY:	DATE:	DRAWING NUMBER: K-UT-SL-137.241W	SHEET 1 OF 1

3K8661PG7642

EXHIBIT "B"

UTAH POWER AND LIGHT COMPANY
SALT LAKE COUNTY, UTAH
L.L. No. K-UT-SL-176W
SHEET 1 OF 1

A TWENTY FIVE (25) FOOT WIDE PERMANENT EASEMENT

Being a twenty five (25) foot wide permanent easement lying twenty five (25) feet Westerly of the following described Survey line, also following an existing Kern River 36" pipeline.

Said twenty five (25) foot wide permanent easement extending over, through and across a portion of a certain tract conveyed to Utah Power and Light Company, and being located in a portion of the East Half of Section 11, Township 1 South, Range 2 West, Salt Lake Base and Meridian, Salt Lake County, Utah. Said tract being more particularly described in Deed Book 8H, Page 237 of the Deed Records of Salt Lake County, Utah, said Survey line being more particularly described as follows:

Beginning at a point on the Northerly line of said tract, from which a Standard Salt Lake County Brass Cap marked "1982" found marking the South Quarter corner of said Section 11 bears South 25°07'35" West, a distance of 2368.39 feet;

THENCE South 00°19'46" West, a distance of 170.11 feet to the point of terminus on the Southerly line of said tract, from which said Standard Salt Lake County Brass Cap marked "1982" found marking the South Quarter corner of said Section 11 bears South 26°58'19" West, a distance of 2215.12 feet, said easement being 10.31 rods in length and contains 0.10 acres of land.

BK8661 PG7643

UTAH POWER AND LIGHT COMPANY
 K-UT-SL-176W
 DEED BOOK 8H, PAGE 237
 D.R.S.L.C.U.
 PORTION OF E/2 SEC. 11

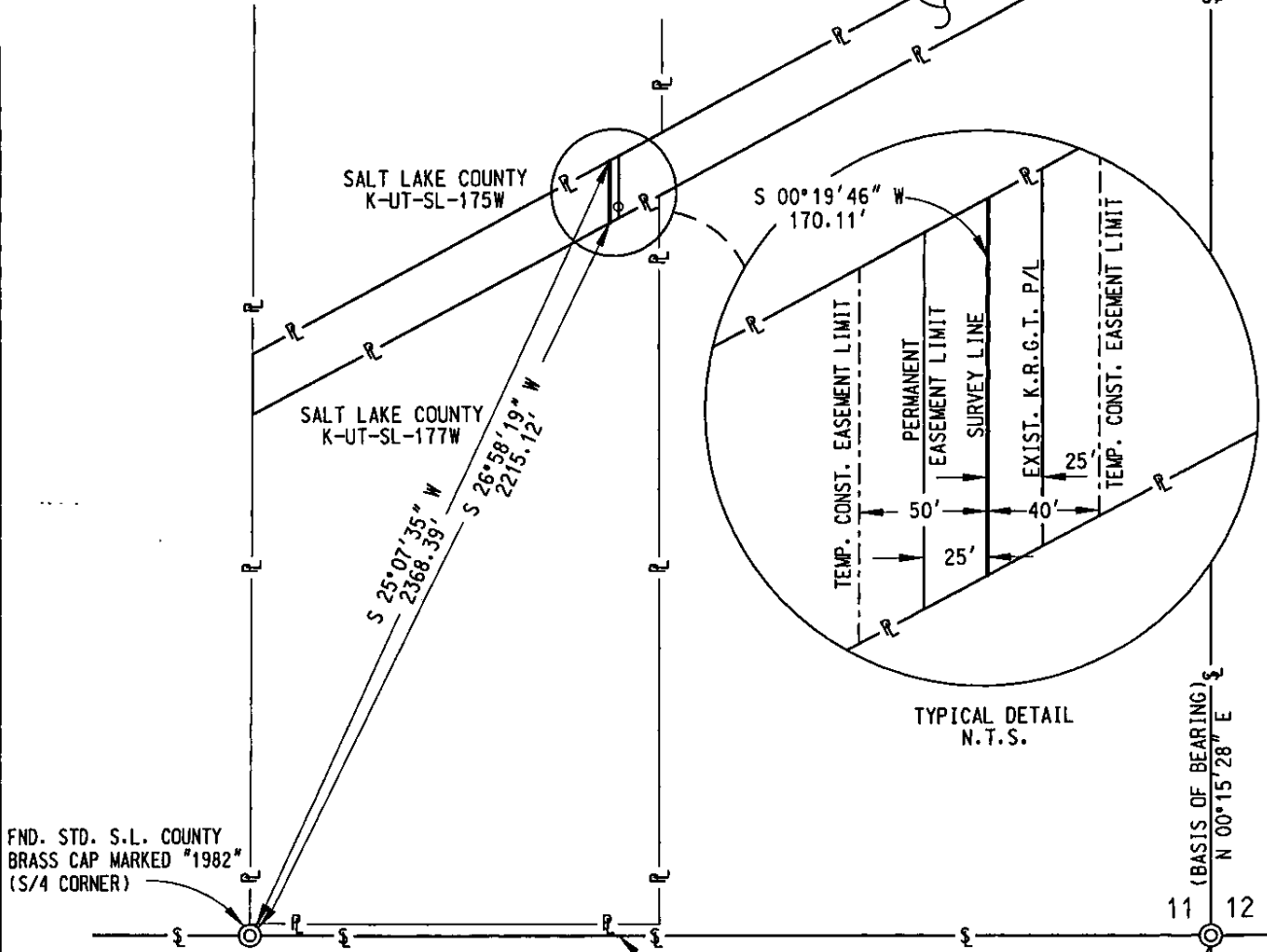

FND. STD. S.L. COUNTY
 BRASS CAP MARKED "1982"
 (S/4 CORNER)

FND. STD. S.L.
 COUNTY BRASS CAP

LEGEND:
 I.R. = IRON ROD
 P.O.B. = POINT OF BEGINNING
 P.O.T. = POINT OF TERMINUS
 FND. = FOUND
 K.R.G.T. = KERN RIVER GAS TRANSMISSION
 P/L = PIPELINE
 SPC = STATE COORDINATES SYSTEM
 NAD = NORTH AMERICAN DATUM
 D.R.S.L.C.U. = DEED RECORDS OF SALT
 LAKE COUNTY, UTAH



- NOTES:**
1. BEARINGS AND DISTANCES ARE BASED ON THE "UTAH COORDINATE SYSTEM 1983 CENTRAL ZONE", DERIVED FROM GPS METHODS. SCALE FACTOR OF 0.999742630 APPLIED TO RODDAGE AND ACREAGE.
 2. BASIS OF BEARING EAST LINE OF SECTION 11 BEING N 00°15'28" E
 3. EASEMENT SURVEY AUGUST 2001.
 4. PREPARED BY: UNIVERSAL ENSCO, INC. 1811 BERING DR. HOUSTON, TX. 77057

I HEREBY CERTIFY THAT THIS
 PLAT IS A TRUE REPRESENTATION
 OF A SURVEY MADE BY ME OR
 UNDER MY DIRECT SUPERVISION.

GARY HENRY GREEN PLS #373234
 PROFESSIONAL LAND SURVEYOR

BK 8661 PG 7644

DRAWING NO.		REFERENCE TITLE		KERN RIVER GAS TRANSMISSION COMPANY PROPERTY PLAT PERMANENT AND TEMPORARY CONSTRUCTION EASEMENTS CROSSING PROPERTY OF UTAH POWER AND LIGHT COMPANY T 1 S - R 2 W, SECTION 11 SALT LAKE COUNTY, UTAH						
NO.	DATE	BY	REVISION DESCRIPTION	W.O. NO.	CHK.	APP.	DRAWN BY: UEI	DATE: 02-08-2002	ISSUED FOR BD:	SCALE: 1" = 500'
							CHECKED BY: UEI	DATE: 02-08-2002	ISSUED FOR CONSTRUCTION:	
							APPROVED BY:	DATE:	DRAWING NUMBER: K-UT-SL-176W	SHEET 1 OF 1

EXHIBIT "C"

UTAH POWER AND LIGHT COMPANY
SALT LAKE COUNTY, UTAH
L.L. No. K-UT-SL-182.01W
SHEET 1 OF 1

A PERMANENT EASEMENT

A permanent easement extending over, through and across a portion of a tract conveyed to Utah Power and Light Company, and being located in the North Half of the Southeast Quarter of Section 23, Township 1 South , Range 2 West, Salt Lake Base and Meridian, Salt Lake County, Utah. Said tract being more particularly described in Deed Book 6849, Page 1680 of the Deed Records of Salt Lake County, Utah, said permanent easement being more particularly described by metes and bounds as follows:

Beginning at an Iron Rod found marking the Northwest Corner of said tract,

THENCE South 89°36'16" East, a distance of 7.33 feet along the North line of said tract to a point;

THENCE South 00°19'41" West, a distance of 689.18 feet to a point on the South line of said tract;

THENCE North 89°42'04" West, a distance of 5.31 feet along the South line of said tract to a Iron Rod w/ Cap marked "LS #343642" found marking the Southwest Corner of said tract;

THENCE North 00°09'36" East, a distance of 689.20 feet along the West line of said tract to the point of beginning. Said easement contains 0.10 acres of land.

BK 8661 PG 7645

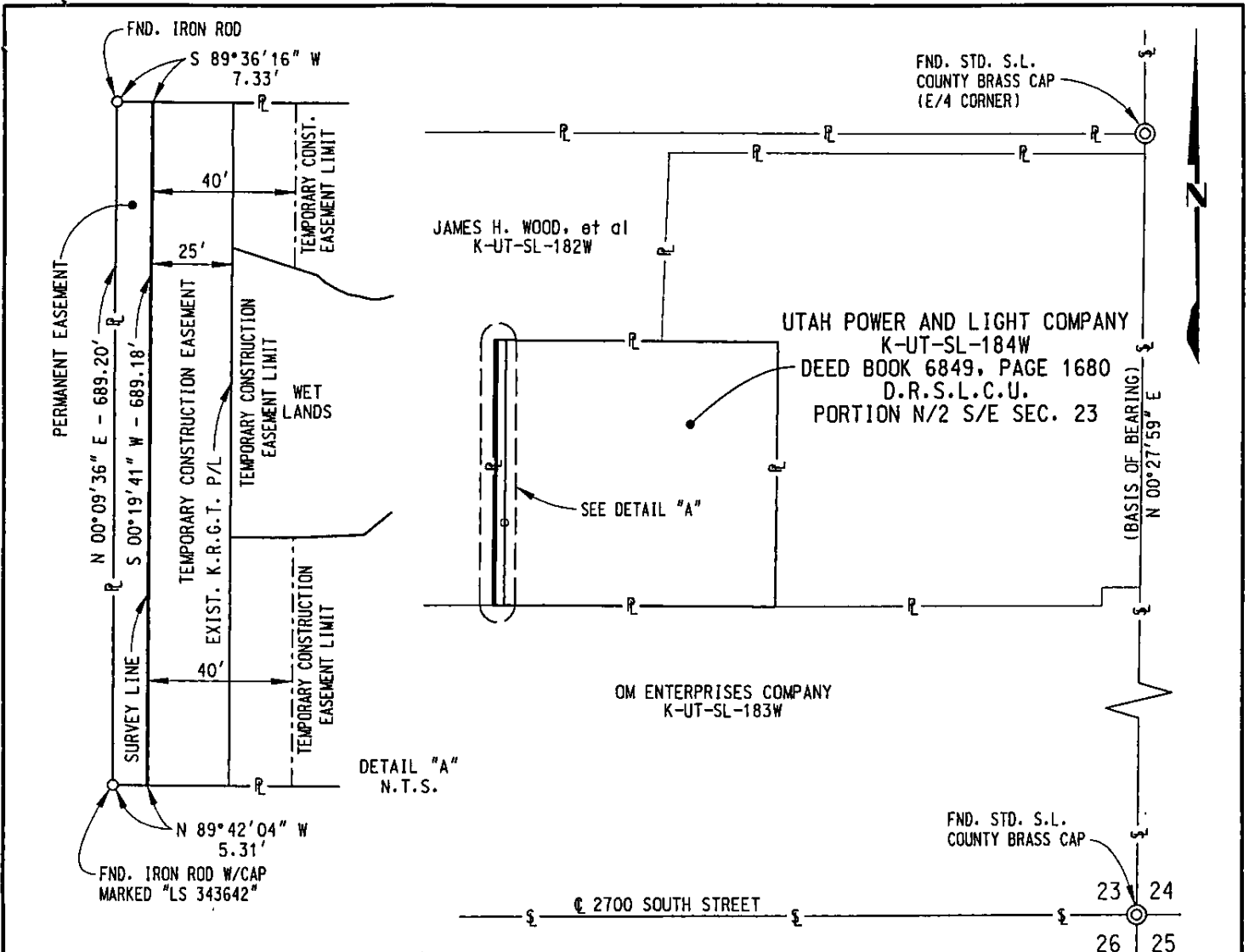

LEGEND:
 I.R. = IRON ROD
 P.O.B. = POINT OF BEGINNING
 P.O.T. = POINT OF TERMINUS
 FND. = FOUND
 K.R.G.T. = KERN RIVER GAS TRANSMISSION
 P/L = PIPELINE
 SPC = STATE COORDINATES SYSTEM
 NAD = NORTH AMERICAN DATUM
 D.R.S.L.C.U. = DEED RECORDS OF SALT LAKE COUNTY, UTAH

- NOTES:**
1. BEARINGS AND DISTANCES ARE BASED ON THE "UTAH COORDINATE SYSTEM 1983 CENTRAL ZONE", DERIVED FROM GPS METHODS. SCALE FACTOR OF 0.999742630 APPLIED TO RODDAGE AND ACREAGE.
 2. BASIS OF BEARING EAST LINE OF SECTION 23 BEING N 00°27'59" E
 3. EASEMENT SURVEY AUGUST 2001.
 4. PREPARED BY: UNIVERSAL ENSCO, INC. 1811 BERING DR. HOUSTON, TX. 77057



LAIRD SURVEYOR
 I HEREBY CERTIFY THAT THIS
 PLAT IS A TRUE REPRESENTATION
 OF A SURVEY MADE BY ME OR
 UNDER MY DIRECT SUPERVISION
 GARY HENRY GREER PLS #973234
 PROFESSIONAL LAND SURVEYOR

DRAWING NO.		REFERENCE TITLE		KERN RIVER GAS TRANSMISSION COMPANY PROPERTY PLAT PERMANENT, TEMPORARY CONST. & A.T.W.S. EASEMENTS CROSSING PROPERTY OF UTAH POWER AND LIGHT COMPANY T 1 S - R 2 W, SECTION 23 SALT LAKE COUNTY, UTAH						
NO.	DATE	BY	REVISION DESCRIPTION	W.O. NO.	CHK.	APP.	DRAWN BY: UEI	DATE: 03-10-2002	ISSUED FOR BID:	SCALE: 1" = 400'
1	08-01-2002	UEI	REVISED CONSTRUCTION EASEMENT AND A.T.W.S.				CHECKED BY: UEI	DATE: 03-10-2002	ISSUED FOR CONSTRUCTION:	
							APPROVED BY:	DATE:	DRAWING NUMBER: K-UT-SL-182.01	SHEET 1 OF 1

BK8661PG7646

EXHIBIT "D"

UTAH POWER AND LIGHT COMPANY
SALT LAKE COUNTY, UTAH
L.L. No. K-UT-SL-184AW
SHEET 1 OF 1

A PERMANENT EASEMENT

A permanent easement extending over, through and across a portion of a certain tract conveyed to Utah Power and Light Company, and being located in a portion of the West Half of the Northeast Quarter of Section 26, Township 1 South, Range 2 West, Salt Lake Base and Meridian, Salt Lake County, Utah. Said tract being more particularly described in Deed Book 4716, Page 191 of the Deed Records of Salt Lake County, Utah, said permanent easement being more particularly described by metes and bounds as follows:

Beginning at a point on the West line of said tract, from which a Standard Salt Lake County Brass Cap found marking the North Quarter corner of said Section 26, bears North 78°54'08" West, a distance of 1003.37 feet;

THENCE South 89°40'19" East, a distance of 13.78 feet to a point;

THENCE South 00°19'41" West, a distance of 27.36 feet to a point;

THENCE South 09°06'16" East, a distance of 35.89 feet to a point;

THENCE South 18°31'32" East, a distance of 933.50 feet to a point;

THENCE South 09°06'16" East, a distance of 44.14 feet to a point;

THENCE South 00°19'59" West, a distance of 141.89 feet to a point on the South line of said tract;

THENCE North 89°35'43" West, a distance of 50.00 feet along the South line of said tract to a point;

THENCE North 00°19'59" East, a distance of 137.70 feet to a point;

THENCE North 09°06'16" West, a distance of 35.89 feet to a point;

THENCE North 18°31'32" West, a distance of 842.41 feet to a point on the West line of said tract;

THENCE North 00°10'08" East, a distance of 161.23 feet along the West line of said tract to the point of beginning. Said permanent easement contains 1.27 acres of land.

BK8561 PG7647

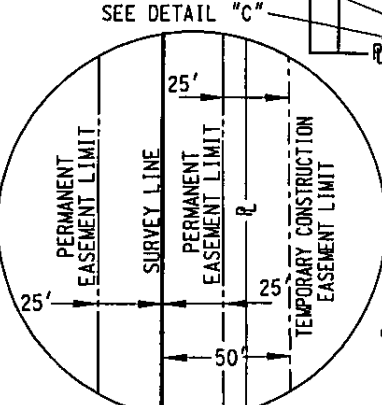
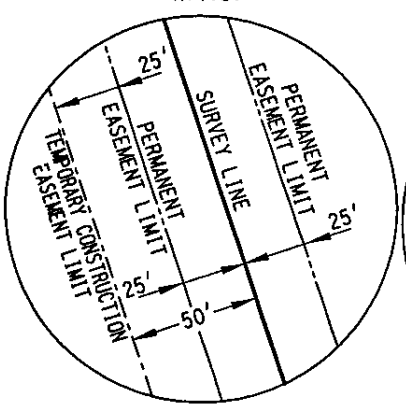
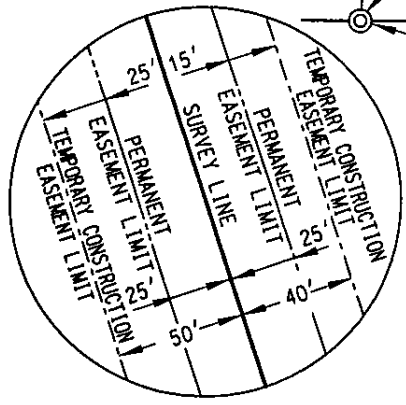
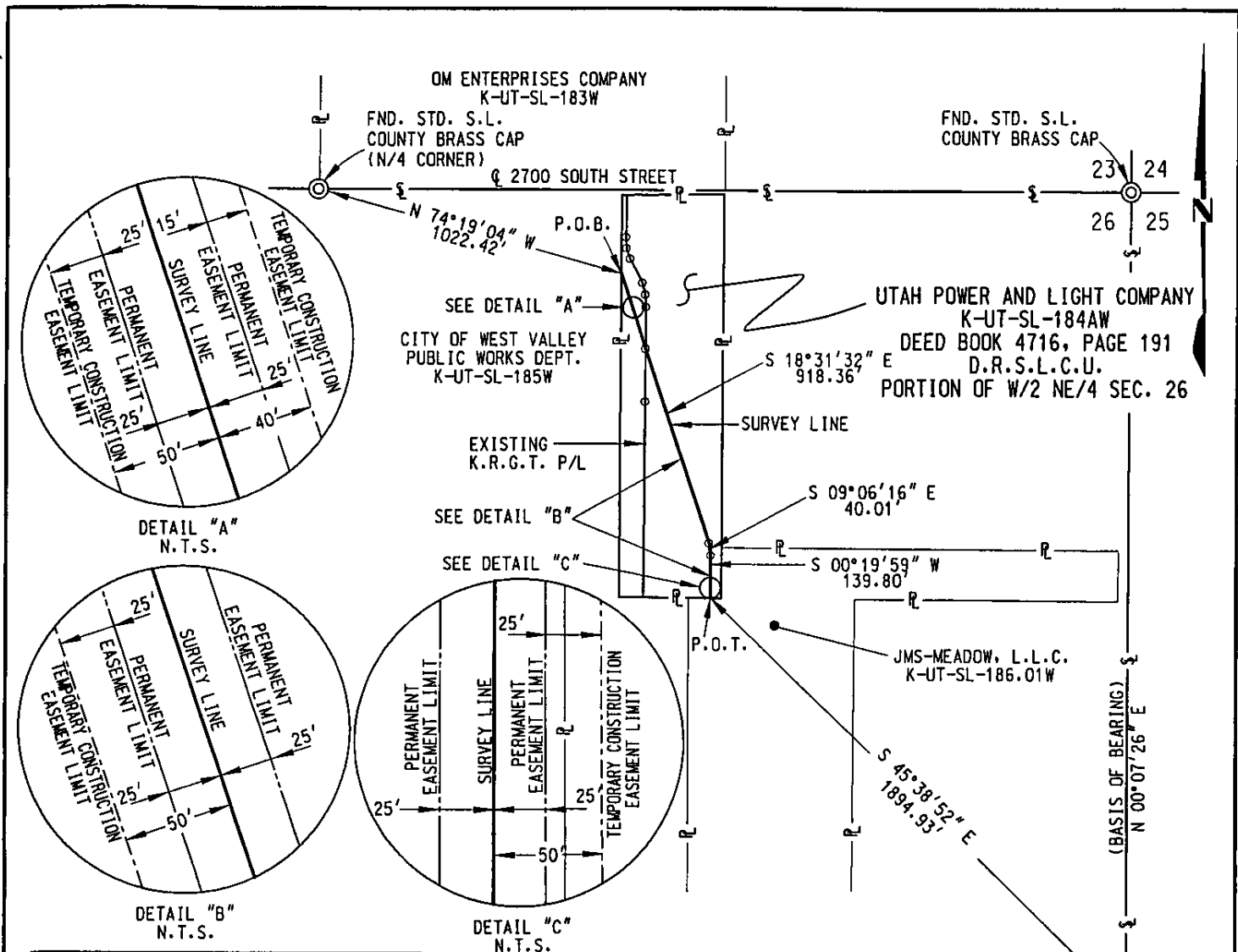

LEGEND:
 I.R. = IRON ROD
 P.O.B. = POINT OF BEGINNING
 P.O.T. = POINT OF TERMINUS
 FND. = FOUND
 K.R.G.T. = KERN RIVER GAS TRANSMISSION
 P/L = PIPELINE
 SPC = STATE COORDINATES SYSTEM
 NAD = NORTH AMERICAN DATUM
 D.R.S.L.C.U. = DEED RECORDS OF SALT LAKE COUNTY, UTAH

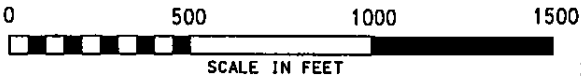

- NOTES:**
1. BEARINGS AND DISTANCES ARE BASED ON THE "UTAH COORDINATE SYSTEM 1983 CENTRAL ZONE", DERIVED FROM GPS METHODS. SCALE FACTOR OF 0.999742630 APPLIED TO RODDAGE AND ACREAGE.
 2. BASIS OF BEARING EAST LINE OF SECTION 26 BEING N 00°07'26" E
 3. EASEMENT SURVEY AUGUST 2001.
 4. PREPARED BY: UNIVERSAL ENSCO, INC. 1811 BERING DR. HOUSTON, TX. 77057

FND. STD. S.L. COUNTY BRASS CAP (E/4 CORNER)
 LAND SURVEYOR
 I HEREBY CERTIFY THAT THIS PLAT IS A TRUE REPRESENTATION OF A SURVEY MADE BY ME OR UNDER MY DIRECT SUPERVISION
 GARY HENRY BREER PLS #373234
 PROFESSIONAL LAND SURVEYOR

DRAWING NO.		REFERENCE TITLE		KERN RIVER GAS TRANSMISSION COMPANY PROPERTY PLAT PERMANENT, TEMPORARY CONST. & A.T.W.S. EASEMENTS CROSSING PROPERTY OF UTAH POWER AND LIGHT COMPANY T 1 S - R 2 W, SECTION 26 SALT LAKE COUNTY, UTAH						
NO.	DATE	BY	REVISION DESCRIPTION	W.O. NO.	CHK.	APP.	DRAWN BY: UEI	DATE: 03-22-2002	ISSUED FOR BID:	SCALE: 1" = 500'
1	08-01-2002	UEI	REVISE TEMPORARY CONSTRUCTION EASEMENTS AND A.T.W.S.				CHECKED BY: UEI	DATE: 03-22-2002	ISSUED FOR CONSTRUCTION:	
							APPROVED BY:	DATE:	DRAWING NUMBER: K-UT-SL-184AW	SHEET 1 OF 3

BK8661 PG 7648

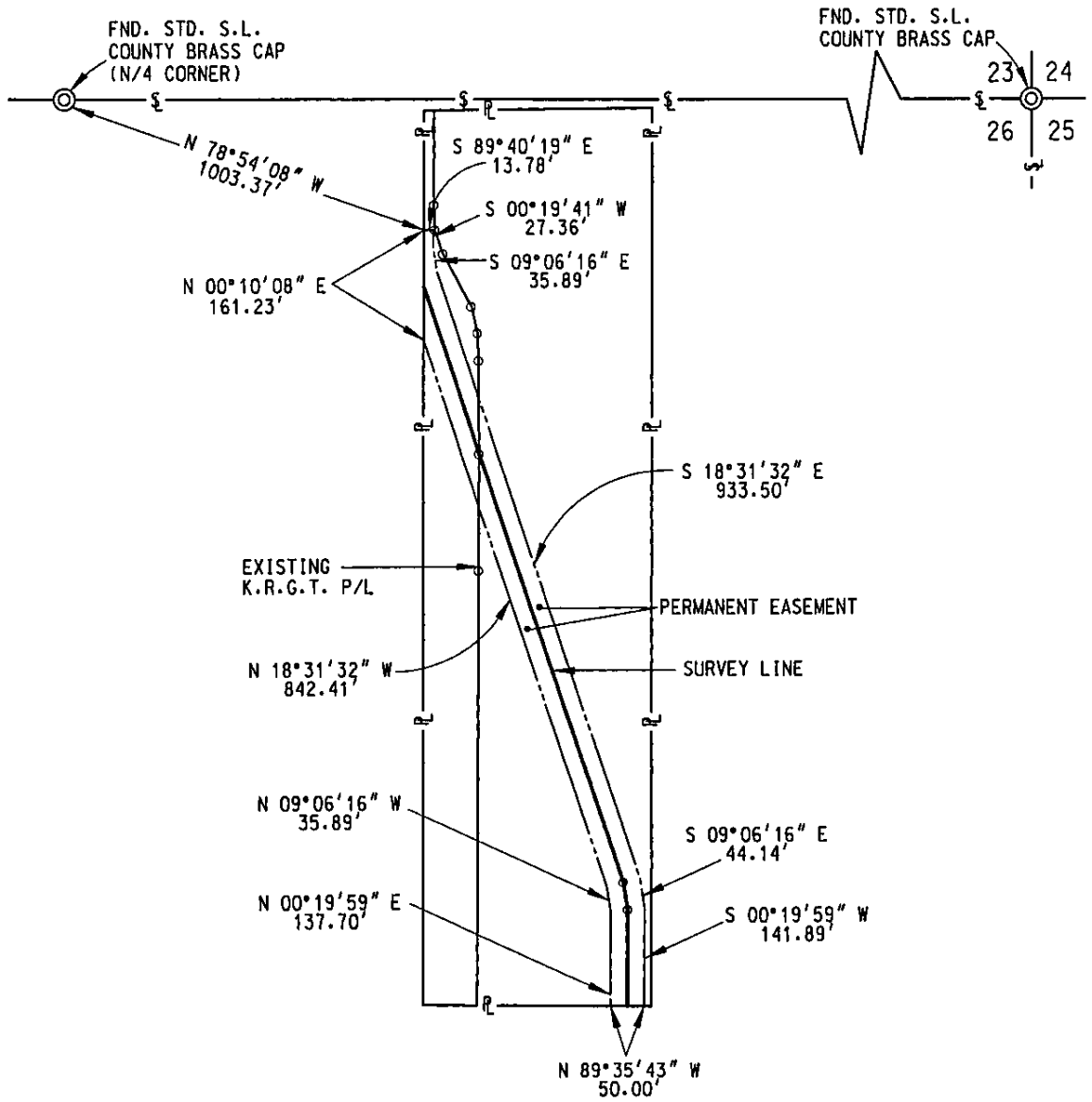

PERMANENT EASEMENT DETAIL
NOT TO SCALE

NOTES:

1. BEARINGS AND DISTANCES ARE BASED ON THE "UTAH COORDINATE SYSTEM 1983 CENTRAL ZONE", DERIVED FROM GPS METHODS. SCALE FACTOR OF 0.999742630 APPLIED TO RODDAGE AND ACREAGE.
2. BASIS OF BEARING EAST LINE OF SECTION 26 BEING N 00°07'26" E
3. EASEMENT SURVEY AUGUST 2001.
4. PREPARED BY: UNIVERSAL ENSCO, INC. 1811 BERING DR. HOUSTON, TX. 77057

DRAWING NO.	REFERENCE TITLE	KERN RIVER GAS TRANSMISSION COMPANY PROPERTY PLAT PERMANENT EASEMENT CROSSING PROPERTY OF UTAH POWER AND LIGHT COMPANY T 1 S - R 2 W, SECTION 26 SALT LAKE COUNTY, UTAH								
NO.	DATE	BY	REVISION DESCRIPTION	W.O. NO.	CHK.	APP.	DRAWN BY: UE1	DATE: 03-22-2002	ISSUED FOR BID:	SCALE: N.T.S.
1	08-01-2002	UE1	REVISE TEMPORARY CONSTRUCTION EASEMENTS AND A.T.W.S.				CHECKED BY: UE1	DATE: 03-22-2002	ISSUED FOR CONSTRUCTION:	
							APPROVED BY:	DATE:	DRAWING NUMBER: K-UT-SL-184AW	SHEET 2
									XTIMEZ ZPATHZ	OF 3

BK8661P6766L9

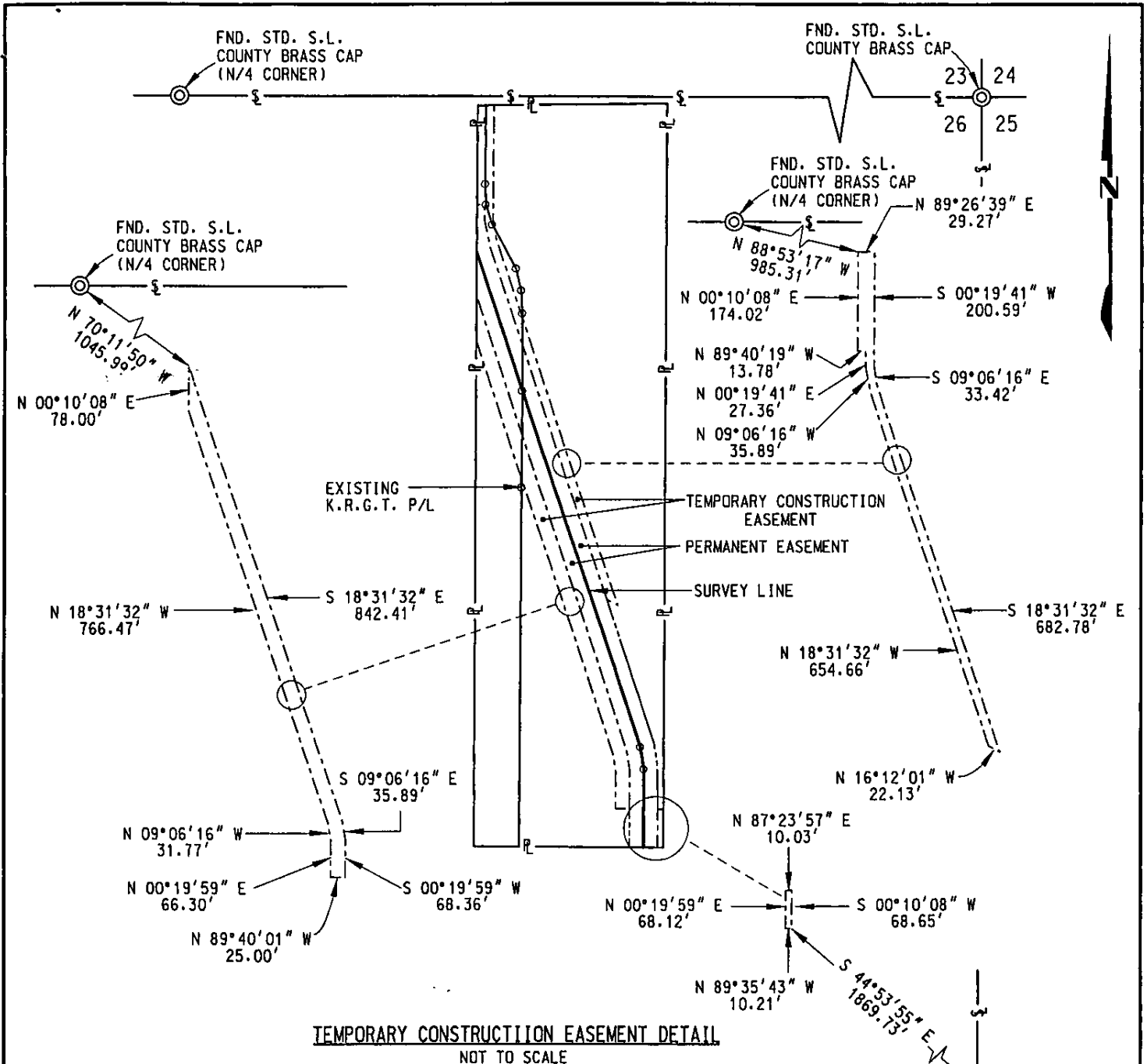

TEMPORARY CONSTRUCTION EASEMENT DETAIL
NOT TO SCALE

NOTES:

1. BEARINGS AND DISTANCES ARE BASED ON THE "UTAH COORDINATE SYSTEM 1983 CENTRAL ZONE", DERIVED FROM GPS METHODS. SCALE FACTOR OF 0.999742630 APPLIED TO RODDAGE AND ACREAGE.
2. BASIS OF BEARING EAST LINE OF SECTION 26 BEING N 00°07'26" E
3. EASEMENT SURVEY AUGUST 2001.
4. PREPARED BY: UNIVERSAL ENSCO, INC. 1811 BERING DR. HOUSTON, TX. 77057

DRAWING NO.	REFERENCE TITLE	KERN RIVER GAS TRANSMISSION COMPANY PROPERTY PLAT TEMPORARY CONSTRUCTION EASEMENT CROSSING PROPERTY OF UTAH POWER AND LIGHT COMPANY T 1 S - R 2 W, SECTION 26 SALT LAKE COUNTY, UTAH								
NO.	DATE	BY	REVISION DESCRIPTION	W.O. NO.	CHK.	APP.	DRAWN BY: UEI	DATE: 03-22-2002	ISSUED FOR BID:	SCALE: N.T.S.
1	08-01-2002	UEI	REVISE TEMPORARY CONSTRUCTION EASEMENTS AND A.T.W.S.				CHECKED BY: UEI	DATE: 03-22-2002	ISSUED FOR CONSTRUCTION:	
							APPROVED BY:	DATE:	DRAWING NUMBER: K-UT-SL-184AW	SHEET 3
									XTIMEZ	OF 3

RX8661PG7650

EXHIBIT "E"

UTAH POWER AND LIGHT COMPANY
SALT LAKE COUNTY, UTAH
L.L. No. K-UT-SL-187W, 187.01W & 187.02W
SHEET 1 OF 1

A FIFTY (50) FOOT WIDE PERMANENT EASEMENT

Being a fifty (50) foot wide permanent easement lying twenty five (25) feet Westerly and twenty five (25) feet Easterly of the following described Survey line, also following an existing Kern River 36" pipeline.

Said fifty (50) foot wide permanent easement extending over, through and across a portion of a certain tract conveyed to Utah Power and Light Company, and being located in a portion of the West Half of the Southeast Quarter of Section 26 and a portion of the West Half of the East Half of Section 35, Township 1 South, Range 2 West, Salt Lake Base and Meridian, Salt Lake County, Utah. Said tract being more particularly described in Deed Book 2024, Page 248, Deed Book 2055, Page 053, Deed Book 3767, Page 265, Deed Book 3852, Page 127 and Book 2034, Page 414 of the Deed Records of Salt Lake County, Utah, said Survey line being more particularly described as follows:

Beginning at a point on the North line of said Section 35, from which a Standard Salt Lake County Brass Cap found marking the North Quarter corner of said Section 35 bears South 89°46'21" West, a distance of 1273.49 feet;

THENCE South 00°19'59" West, a distance of 1372.42 feet to a point;

THENCE South 07°54'12" West, a distance of 40.01 feet to a point;

THENCE South 15°27'16" West, a distance of 532.54 feet to a point;

THENCE South 07°53'21" West, a distance of 40.01 feet to a point;

THENCE South 00°19'50" West, a distance of 1983.81 feet to the point of terminus on the South line of said tract, from which a Standard Salt Lake County Brass Cap found marking the Southeast corner of said Section 35 bears South 49°12'16" East, a distance of 2039.42 feet; Said easement being 240.53 rods in length and contains 4.56 acres of land.

BK 8661 PG 7651

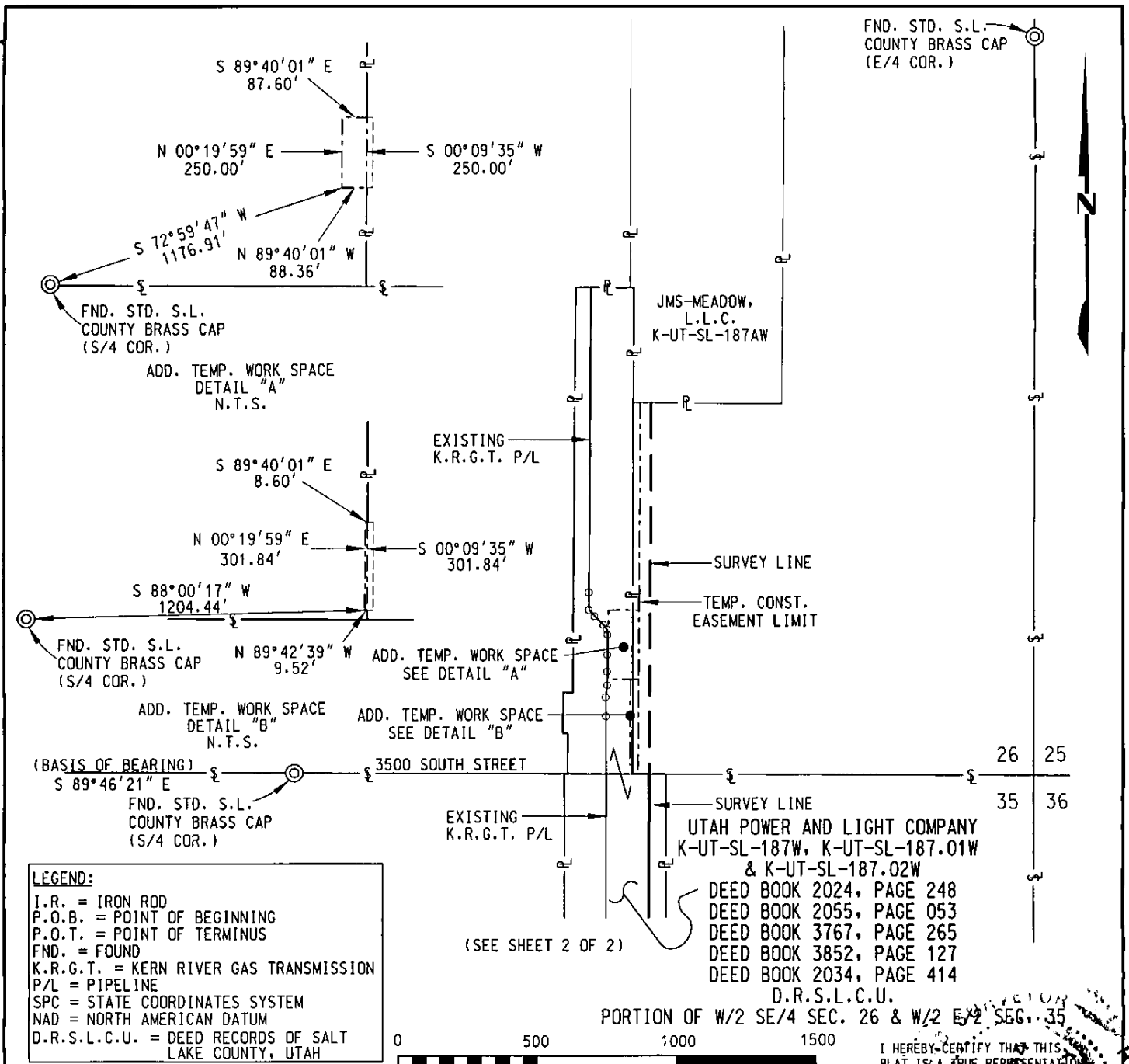

LEGEND:
 I.R. = IRON ROD
 P.O.B. = POINT OF BEGINNING
 P.O.T. = POINT OF TERMINUS
 FND. = FOUND
 K.R.G.T. = KERN RIVER GAS TRANSMISSION
 P/L = PIPELINE
 SPC = STATE COORDINATES SYSTEM
 NAD = NORTH AMERICAN DATUM
 D.R.S.L.C.U. = DEED RECORDS OF SALT LAKE COUNTY, UTAH

- NOTES:**
1. BEARINGS AND DISTANCES ARE BASED ON THE "UTAH COORDINATE SYSTEM 1983 CENTRAL ZONE", DERIVED FROM GPS METHODS. SCALE FACTOR OF 0.999742630 APPLIED TO RODDAGE AND ACREAGE.
 2. BASIS OF BEARING SOUTH LINE OF SECTION 26 BEING S 89°46'21" E
 3. EASEMENT SURVEY AUGUST 2001.
 4. PREPARED BY: UNIVERSAL ENSCO, INC. 1811 BERING DR. HOUSTON, TX. 77057

PORTION OF W/2 SE/4 SEC. 26 & W/2 E/2 SEC. 35

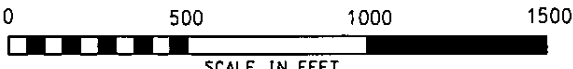

I HEREBY CERTIFY THAT THIS PLAT IS A TRUE REPRESENTATION OF A SURVEY MADE BY ME OR UNDER MY DIRECT SUPERVISION.

Gary Henry Greer
 GARY HENRY GREER, PLS #37323
 PROFESSIONAL LAND SURVEYOR

DRAWING NO.		REFERENCE TITLE		KERN RIVER GAS TRANSMISSION COMPANY PROPERTY PLAT PERMANENT, TEMP. CONSTRUCTION & A.T.W.S. EASEMENTS CROSSING PROPERTY OF UTAH POWER AND LIGHT COMPANY T 1 S - R 2 W, SECTION 26 AND 35 SALT LAKE COUNTY, UTAH						
NO.	DATE	BY	REVISION DESCRIPTION	W.O. NO.	CHK.	APP.	DRAWN BY: UEI	DATE: 04-05-2002	ISSUED FOR BID:	SCALE: 1" = 500'
1	08-02-2002	UEI	REVISE TEMPORARY CONSTRUCTION EASEMENTS AND A.T.W.S.				CHECKED BY: UEI	DATE: 04-05-2002	ISSUED FOR CONSTRUCTION:	
							APPROVED BY:	DATE:	DRAWING NUMBER: K-UT-SL-187W, 187.01W SHEET 1 & 187.02W OF 3	



BK 8661 PG 7652

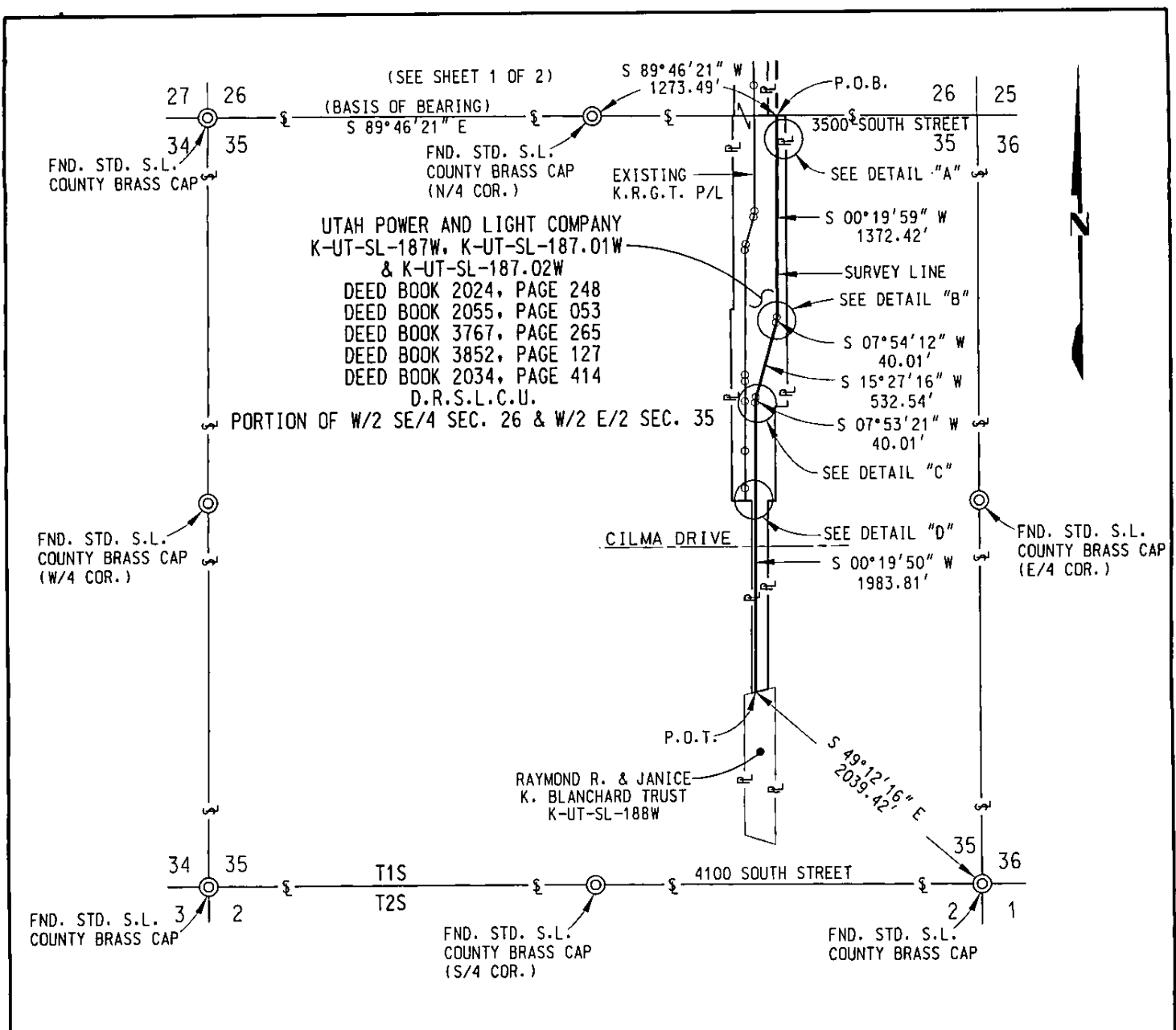

UTAH POWER AND LIGHT COMPANY
 K-UT-SL-187W, K-UT-SL-187.01W
 & K-UT-SL-187.02W
 DEED BOOK 2024, PAGE 248
 DEED BOOK 2055, PAGE 053
 DEED BOOK 3767, PAGE 265
 DEED BOOK 3852, PAGE 127
 DEED BOOK 2034, PAGE 414
 D.R.S.L.C.U.

PORTION OF W/2 SE/4 SEC. 26 & W/2 E/2 SEC. 35

LEGEND:

- I.R. = IRON ROD
- P.O.B. = POINT OF BEGINNING
- P.O.T. = POINT OF TERMINUS
- FND. = FOUND
- K.R.G.T. = KERN RIVER GAS TRANSMISSION
- P/L = PIPELINE
- SPC = STATE COORDINATES SYSTEM
- NAD = NORTH AMERICAN DATUM
- D.R.S.L.C.U. = DEED RECORDS OF SALT LAKE COUNTY, UTAH

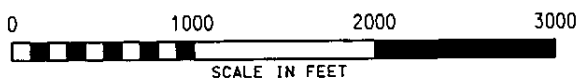

NOTES:

1. BEARINGS AND DISTANCES ARE BASED ON THE "UTAH COORDINATE SYSTEM 1983 CENTRAL ZONE", DERIVED FROM GPS METHODS. SCALE FACTOR OF 0.999742630 APPLIED TO RODDAGE AND ACREAGE.
2. BASIS OF BEARING SOUTH LINE OF SECTION 26 BEING S 89°46'21" E
3. EASEMENT SURVEY AUGUST 2001.
4. PREPARED BY: UNIVERSAL ENSCO, INC. 1811 BERING DR. HOUSTON, TX. 77057

DRAWING NO.		REFERENCE TITLE			KERN RIVER GAS TRANSMISSION COMPANY PROPERTY PLAT PERMANENT, TEMP. CONSTRUCTION & A.T.W.S. EASEMENTS CROSSING PROPERTY OF UTAH POWER AND LIGHT COMPANY T 1 S - R 2 W, SECTION 26 AND 35 SALT LAKE COUNTY, UTAH					
NO.	DATE	BY	REVISION DESCRIPTION	W.O. NO.	CHK.	APP.	DRAWN BY: UEI	DATE: 04-05-2002	ISSUED FOR BID:	SCALE: 1" = 1000'
1	08-02-2002	UEI	REVISE TEMPORARY CONSTRUCTION EASEMENTS AND A.T.W.S.				CHECKED BY: UEI	DATE: 04-05-2002	ISSUED FOR CONSTRUCTION:	
							APPROVED BY:	DATE:	DRAWING NUMBER: K-UT-SL-187W, 187.01W SHEET 2 & 187.02W OF 3	

BK 8661 PG 7653

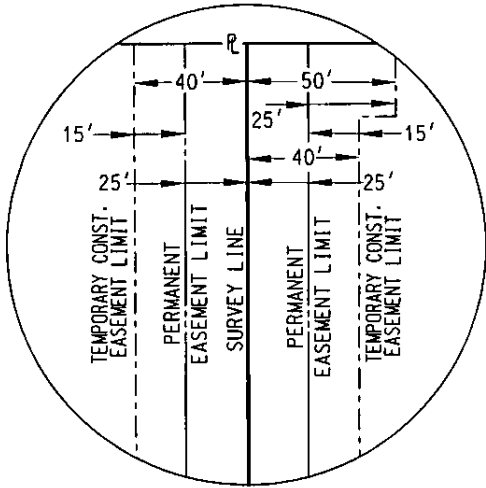

DETAIL "A"
N.T.S.

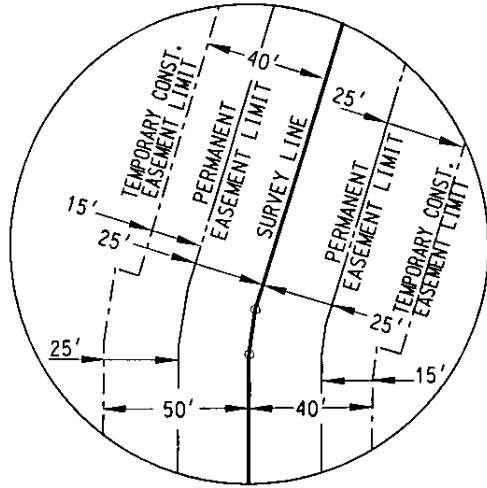

DETAIL "C"
N.T.S.

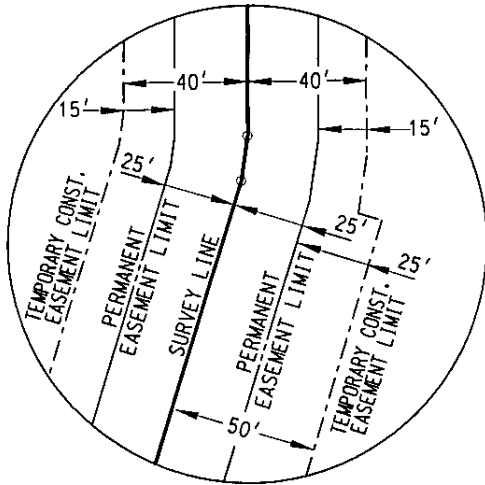

DETAIL "B"
N.T.S.

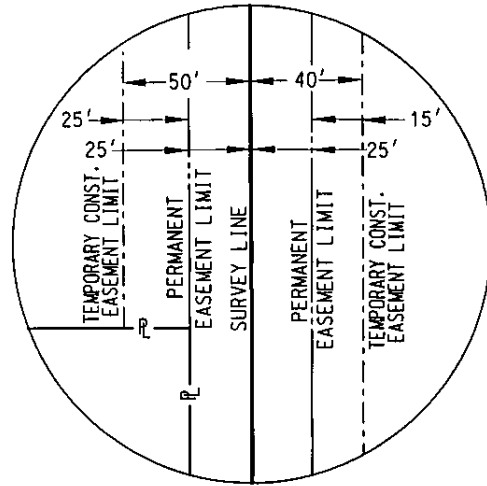

DETAIL "D"
N.T.S.



NOTES:

1. BEARINGS AND DISTANCES ARE BASED ON THE "UTAH COORDINATE SYSTEM 1983 CENTRAL ZONE", DERIVED FROM GPS METHODS. SCALE FACTOR OF 0.999742630 APPLIED TO RODDAGE AND ACREAGE.
2. BASIS OF BEARING SOUTH LINE OF SECTION 26 BEING S 89°46'21" E
3. EASEMENT SURVEY AUGUST 2001.
4. PREPARED BY: UNIVERSAL ENSCO, INC. 1811 BERING DR. HOUSTON, TX. 77057

LEGEND:	
I.R.	= IRON ROD
P.O.B.	= POINT OF BEGINNING
P.O.T.	= POINT OF TERMINUS
FND.	= FOUND
K.R.G.T.	= KERN RIVER GAS TRANSMISSION
P/L	= PIPELINE
SPC	= STATE COORDINATES SYSTEM
NAD	= NORTH AMERICAN DATUM
D.R.S.L.C.U.	= DEED RECORDS OF SALT LAKE COUNTY, UTAH

DRAWING NO.		REFERENCE TITLE		KERN RIVER GAS TRANSMISSION COMPANY PROPERTY PLAT PERMANENT, TEMP. CONSTRUCTION & A.T.W.S. EASEMENTS CROSSING PROPERTY OF UTAH POWER AND LIGHT COMPANY T 1 S - R 2 W, SECTION 26 AND 35 SALT LAKE COUNTY, UTAH						
NO.	DATE	BY	REVISION DESCRIPTION	W.O. NO.	CHK.	APP.	DRAWN BY: UEI	DATE: 04-05-2002	ISSUED FOR BID:	SCALE: 1" = 1000'
1	08-02-2002	UEI	REVISE TEMPORARY CONSTRUCTION EASEMENTS AND A.T.W.S.				CHECKED BY: UEI	DATE: 04-05-2002	ISSUED FOR CONSTRUCTION:	
							APPROVED BY:	DATE:	DRAWING NUMBER: K-UT-SL-187W, 187.01W & 187.02W	SHEET 3 OF 3

RK8661 PG765L4

EXHIBIT "F"

UTAH POWER AND LIGHT COMPANY
SALT LAKE COUNTY, UTAH
L.L. No. K-UT-SL-193W
SHEET 1 OF 1

A FIFTY (50) FOOT WIDE PERMANENT EASEMENT

Being a fifty (50) foot wide permanent easement lying twenty five (25) feet Westerly and twenty five (25) feet Easterly of the following described Survey line, also following an existing Kern River 36" pipeline.

Said fifty (50) foot wide permanent easement extending over, through and across a portion of a certain tract conveyed to Utah Power and Light Company, and being located in a portion of the Southwest Quarter of the Southeast Quarter of Section 35, Township 1 South, Range 2 West, Salt Lake Base and Meridian, Salt Lake County, Utah. Said tract being more particularly described in Deed Book 4706, Page 861 of the Deed Records of Salt Lake County, Utah, said Survey line being more particularly described as follows:

Beginning at a point on the North line of said tract, from which a standard Salt Lake County Brass Cap found marking the South Quarter corner of said Section 35 bears South 74°29'58" West, a distance of 1150.25 feet;

THENCE South 00°19'50" West, a distance of 278.57 feet to the point of terminus on the South line of said tract, from which a standard Salt Lake County Brass Cap found marking the South Quarter corner of said Section 35 bears South 88°30'27" West, a distance of 1107.18 feet, said easement being 16.88 rods in length and contains 0.32 acres of land.

BK8661 PG7655

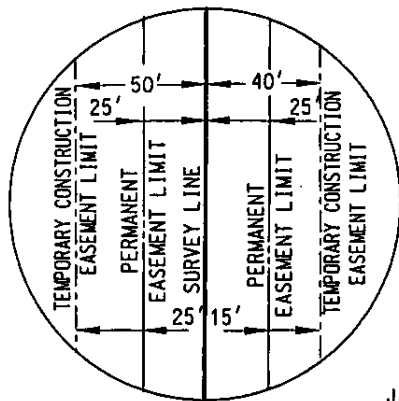

TYPICAL DETAIL
N.T.S.

RAYMOND R. AND
JANICE K. BLANCHARD TRUST
K-UT-SL-195W

UTAH POWER AND LIGHT COMPANY
K-UT-SL-193W
DEED BOOK 4706, PAGE 861
D.R.S.L.C.U.
PORTION OF SW/4 SE/4 SEC.35

FND. STD. S.L.
COUNTY BRASS CAP
(S/4 COR.)

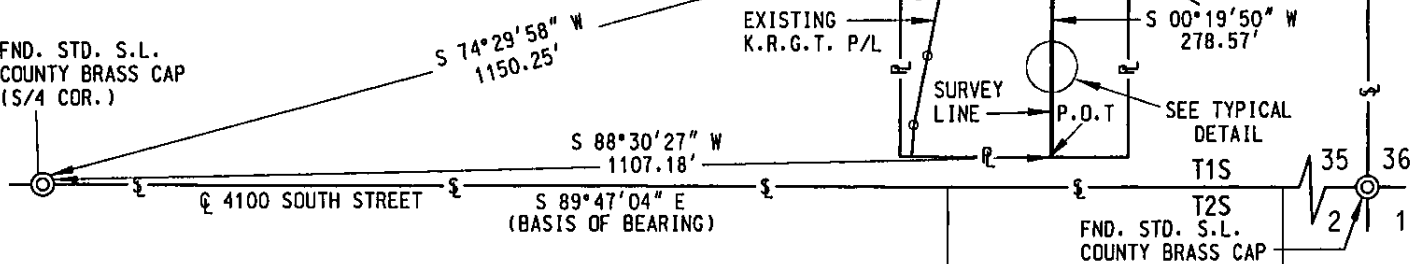

LEGEND:
 I.R. = IRON ROD
 P.O.B. = POINT OF BEGINNING
 P.O.T. = POINT OF TERMINUS
 FND. = FOUND
 K.R.G.T. = KERN RIVER GAS TRANSMISSION
 P/L = PIPELINE
 SPC = STATE COORDINATES SYSTEM
 NAD = NORTH AMERICAN DATUM
 D.R.S.L.C.U. = DEED RECORDS OF SALT LAKE COUNTY, UTAH



- NOTES:**
1. BEARINGS AND DISTANCES ARE BASED ON THE "UTAH COORDINATE SYSTEM 1983 CENTRAL ZONE", DERIVED FROM GPS METHODS. SCALE FACTOR OF 0.999742630 APPLIED TO RODDAGE AND ACREEGE.
 2. BASIS OF BEARING SOUTH LINE OF SECTION 35 BEING S 89°47'04" E
 3. EASEMENT SURVEY AUGUST 2001.
 4. PREPARED BY: UNIVERSAL ENSCO, INC. 1811 BERING DR. HOUSTON, TX. 77057

LAND SURVEYOR
 I HEREBY CERTIFY THAT THIS
 PLAT IS A TRUE REPRESENTATION
 OF A SURVEY MADE BY ME OR
 UNDER MY DIRECT SUPERVISOR ON
 GARY HENRY GREER P.L.S. #673234
 PROFESSIONAL LAND SURVEYOR

DRAWING NO.		REFERENCE TITLE		KERN RIVER GAS TRANSMISSION COMPANY PROPERTY PLAT PERMANENT, TEMPORARY CONST. & A.T.W.S. EASEMENTS CROSSING PROPERTY OF UTAH POWER AND LIGHT COMPANY T 1 S - R 2 W, SECTION 35 SALT LAKE COUNTY, UTAH						
NO.	DATE	BY	REVISION DESCRIPTION	W.O. NO.	CHK.	APP.	DRAWN BY: UEI	DATE: 03-27-2002	ISSUED FOR BID:	SCALE: 1" = 200'
01	07-31-02	UEI	REVISED A.T.W.S.				CHECKED BY: UEI	DATE: 03-27-2002	ISSUED FOR CONSTRUCTION:	
							APPROVED BY:	DATE:	DRAWING NUMBER: K-UT-SL-193W	SHEET 1 OF 1

BK8661 PG7656

EXHIBIT "G"

UTAH POWER AND LIGHT COMPANY
SALT LAKE COUNTY, UTAH
L.L. No. K-UT-SL-196W
SHEET 1 OF 1

A FIFTY (50) FOOT WIDE PERMANENT EASEMENT

Being a fifty (50) foot wide permanent easement lying twenty five (25) feet Westerly and twenty five (25) feet Easterly of the following described Survey line, also following an existing Kern River 36" pipeline.

Said fifty (50) foot wide permanent easement extending over, through and across a portion of a certain tract conveyed to Utah Power and Light Company, and being located in a portion of the Northeast Quarter of Section 2, Township 2 South, Range 2 West, Salt Lake Base and Meridian, Salt Lake County, Utah. Said tract being more particularly described in Deed Book 5101, Page 961, Book 5211, Page 347 and Book 2081, Page 284 of the Deed Records of Salt Lake County, Utah, said Survey line being more particularly described as follows:

Beginning at a point on the North line of said Section 2, from which a Standard Salt Lake County Brass Cap found marking the Northeast Quarter of said Section 2 bears South 89°47'04" East, a distance of 1551.60 feet;

THENCE South 00°19'50" West, a distance of 798.08 feet to a point;

THENCE South 31°51'32" West, a distance of 134.83 feet to a point;

THENCE South 00°19'13" West, a distance of 302.53 feet to a point;

THENCE South 40°50'56" East, a distance of 270.75 feet to a point;

THENCE South 30°33'12" East, a distance of 40.00 feet to a point;

THENCE South 20°16'10" East, a distance of 40.02 feet to a point;

THENCE South 09°57'50" East, a distance of 40.00 feet to a point;

THENCE South 00°19'23" West, a distance of 563.90 feet to a point;

THENCE South 08°03'40" West, a distance of 40.02 feet to a point;

THENCE South 15°47'52" West, a distance of 40.01 feet to a point;

THENCE South 23°32'44" West, a distance of 429.15 feet to the point of terminus on a Westerly line of said tract, from which a Standard Salt Lake County Brass Cap found marking the East Quarter corner of said Section 2 bears South 87°05'33" East, a distance of 1598.33 feet, said easement being 163.59 rods in length and contains 3.10 acres of land.

BK8661 PG7657

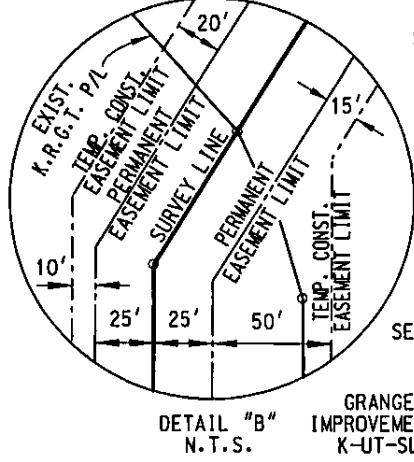
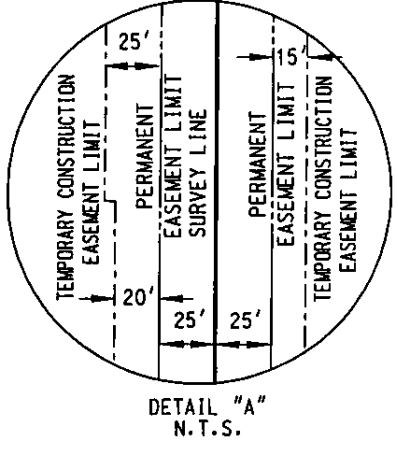
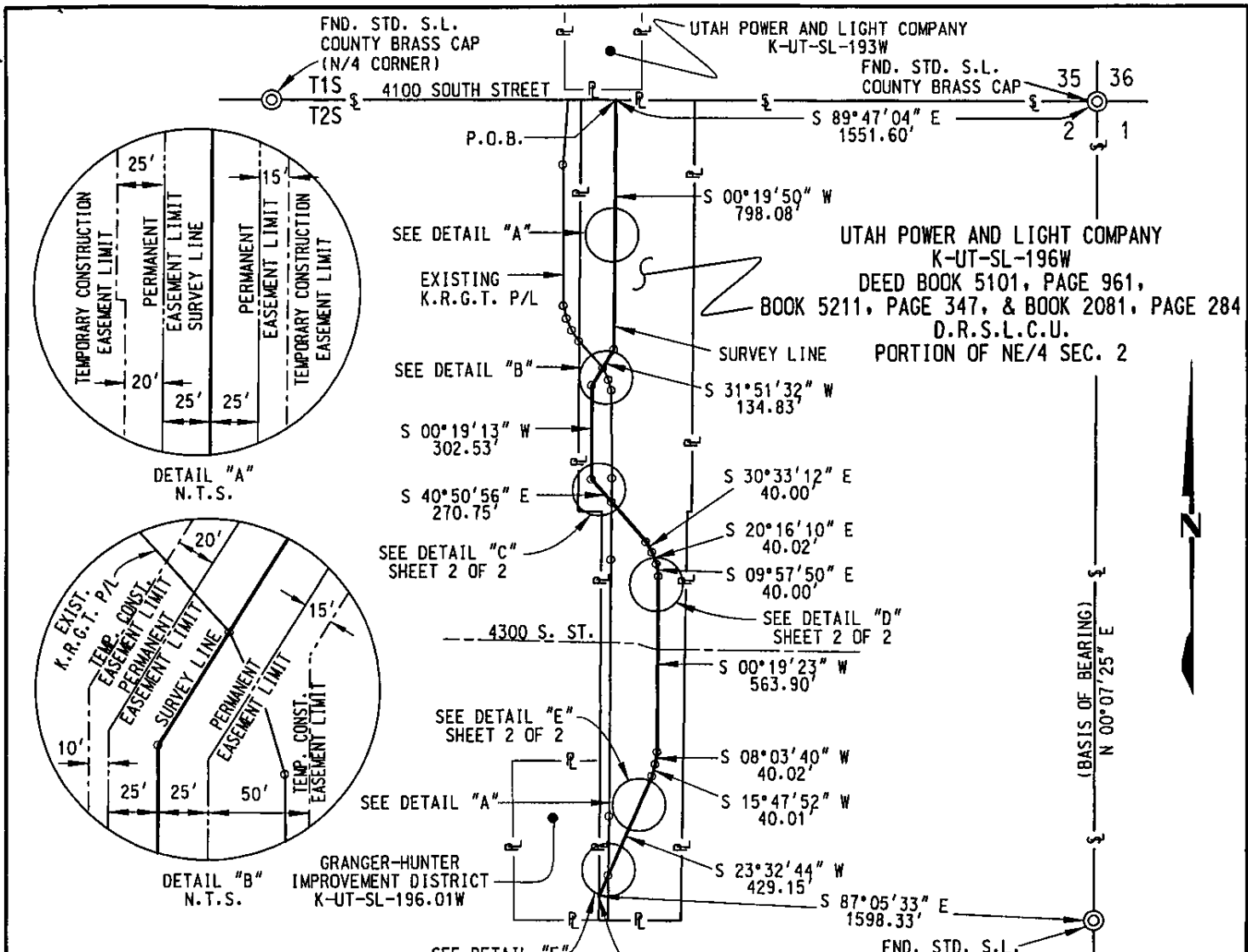

LEGEND:
 I.R. = IRON ROD
 P.O.B. = POINT OF BEGINNING
 P.O.T. = POINT OF TERMINUS
 FND. = FOUND
 K.R.G.T. = KERN RIVER GAS TRANSMISSION
 P/L = PIPELINE
 SPC = STATE COORDINATES SYSTEM
 NAD = NORTH AMERICAN DATUM
 D.R.S.L.C.U. = DEED RECORDS OF SALT LAKE COUNTY, UTAH

- NOTES:**
1. BEARINGS AND DISTANCES ARE BASED ON THE "UTAH COORDINATE SYSTEM 1983 CENTRAL ZONE", DERIVED FROM GPS METHODS. SCALE FACTOR OF 0.999742630 APPLIED TO RODDAGE AND ACREAGE.
 2. BASIS OF BEARING EAST LINE OF SECTION 2 BEING N 00°07'25" E
 3. EASEMENT SURVEY AUGUST 2001.
 4. PREPARED BY: UNIVERSAL ENSCO, INC. 1811 BERING DR. HOUSTON, TX. 77057



I HEREBY CERTIFY THAT THIS PLAT IS A TRUE REPRESENTATION OF A SURVEY MADE BY ME OR UNDER MY DIRECT SUPERVISION.

Garret Henry Coker
 GARRET HENRY COKER PLS #373234
 PROFESSIONAL LAND SURVEYOR

DRAWING NO.	REFERENCE TITLE	KERN RIVER GAS TRANSMISSION COMPANY PROPERTY PLAT PERMANENT, TEMPORARY CONST. & A.T.W.S. EASEMENTS CROSSING PROPERTY OF UTAH POWER AND LIGHT COMPANY T 2 S - R 2 W, SECTION 2 SALT LAKE COUNTY, UTAH								
NO.	DATE	BY	REVISION DESCRIPTION	W.O. NO.	CHK.	APP.	DRAWN BY: UEI	DATE: 03-21-2002	ISSUED FOR BID:	SCALE: 1" = 500'
01	08-02-02	UEI	REVISED TEMP. CONST. EASEMENT & A.T.W.S.				CHECKED BY: UEI	DATE: 03-21-2002	ISSUED FOR CONSTRUCTION:	SHEET 1 OF 2
							APPROVED BY:	DATE:	DRAWING NUMBER: K-UT-SL-196W	

BK8661PG7658

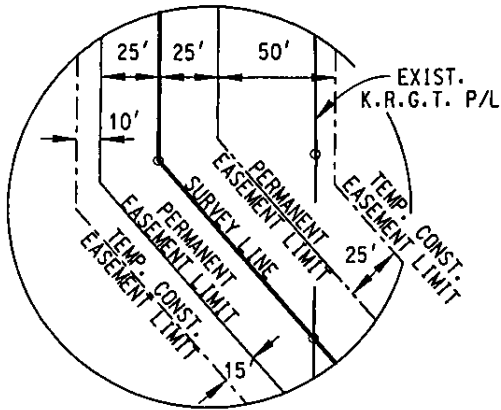

DETAIL "C"
N.T.S.

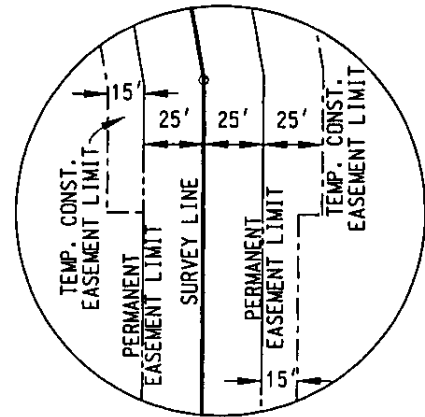

DETAIL "D"
N.T.S.

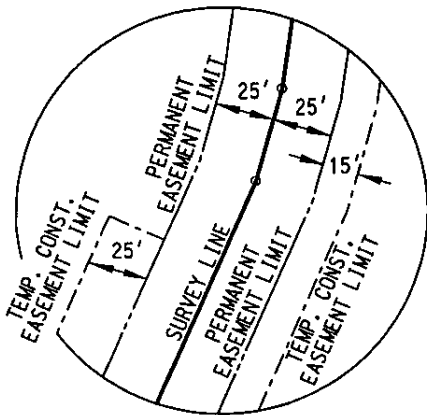

DETAIL "E"
N.T.S.

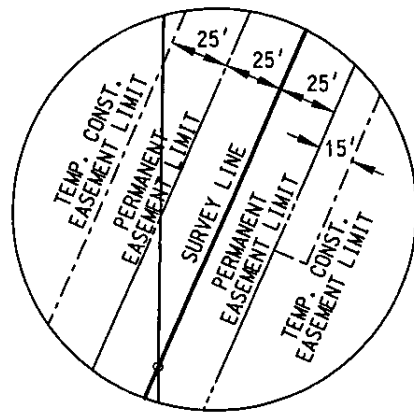

DETAIL "F"
N.T.S.

LEGEND:

- I.R. = IRON ROD
- P.O.B. = POINT OF BEGINNING
- P.O.T. = POINT OF TERMINUS
- FND. = FOUND
- K.R.G.T. = KERN RIVER GAS TRANSMISSION
- P/L = PIPELINE
- SPC = STATE COORDINATES SYSTEM
- NAD = NORTH AMERICAN DATUM
- D.R.S.L.C.U. = DEED RECORDS OF SALT LAKE COUNTY, UTAH



NOTES:

1. BEARINGS AND DISTANCES ARE BASED ON THE "UTAH COORDINATE SYSTEM 1983 CENTRAL ZONE", DERIVED FROM GPS METHODS. SCALE FACTOR OF 0.999742630 APPLIED TO RODDAGE AND ACREAGE.
2. BASIS OF BEARING EAST LINE OF SECTION 2 BEING N 00°07'25" E
3. EASEMENT SURVEY AUGUST 2001.
4. PREPARED BY: UNIVERSAL ENSCO, INC. 1811 BERING DR. HOUSTON, TX. 77057

DRAWING NO.	REFERENCE TITLE	KERN RIVER GAS TRANSMISSION COMPANY PROPERTY PLAT PERMANENT, TEMPORARY CONST. & A.T.W.S. EASEMENTS CROSSING PROPERTY OF UTAH POWER AND LIGHT COMPANY T 2 S - R 2 W, SECTION 2 SALT LAKE COUNTY, UTAH								
NO.	DATE	BY	REVISION DESCRIPTION	W.O. NO.	CHK.	APP.	DRAWN BY: UEI	DATE: 03-21-2002	ISSUED FOR BID:	SCALE: 1" = 500'
01	08-02-02	UEI	REVISED TEMP. CONST. EASEMENT & A.T.W.S.				CHECKED BY: UEI	DATE: 03-21-2002	ISSUED FOR CONSTRUCTION:	
							APPROVED BY:	DATE:	DRAWING NUMBER: K-UT-SL-196W	SHEET 2 OF 2

RK8661PG7659

EXHIBIT "H"

UTAH POWER AND LIGHT COMPANY
SALT LAKE COUNTY, UTAH
L.L. No. K-UT-SL-198W
SHEET 1 OF 1

A FIFTY (50) FOOT WIDE PERMANENT EASEMENT

Being a fifty (50) foot wide permanent easement lying twenty five (25) feet Westerly and twenty five (25) feet Easterly of the following described Survey line.

Said fifty (50) foot wide permanent easement extending over, through and across a portion of a certain tract conveyed to Utah Power and Light Company, and being located in a portion of the Northwest Quarter of the Southeast Quarter of Section 2, Township 2 South, Range 2 West, Salt Lake Base and Meridian, Salt Lake County, Utah. Said tract being more particularly described in Deed Book 5283, Page 1158 of the Deed Records of Salt Lake County, Utah, said Survey line being more particularly described as follows:

Beginning at a point on the North line of said tract, from which a Standard Salt Lake County Brass Cap found marking the East Quarter Corner of said Section 2 bears South 89°52'10" East, a distance of 1624.71 feet;

THENCE South 15°48'42" West, a distance of 4.04 feet to a point;

THENCE South 08°03'40" West, a distance of 40.02 feet to a point;

THENCE South 00°19'51" West, a distance of 849.55 feet to a point of exit on the North property line of the Denver and Rio Grande Western Railroad;

THENCE South 00°19'51" West, a distance of 130.31 feet to a point of entry on the South property line of the Denver and Rio Grande Western Railroad;

THENCE South 00°19'51" West, a distance of 298.94 feet to a point of terminus on the South line of said tract, from which a Standard Salt Lake County Brass Cap found marking the Southeast Quarter of said Section 2 bears South 50°58'59" East, a distance of 2101.58 feet, said easement being 72.28 rods in length and contains 1.37 acres of land.

BK8661PG7660

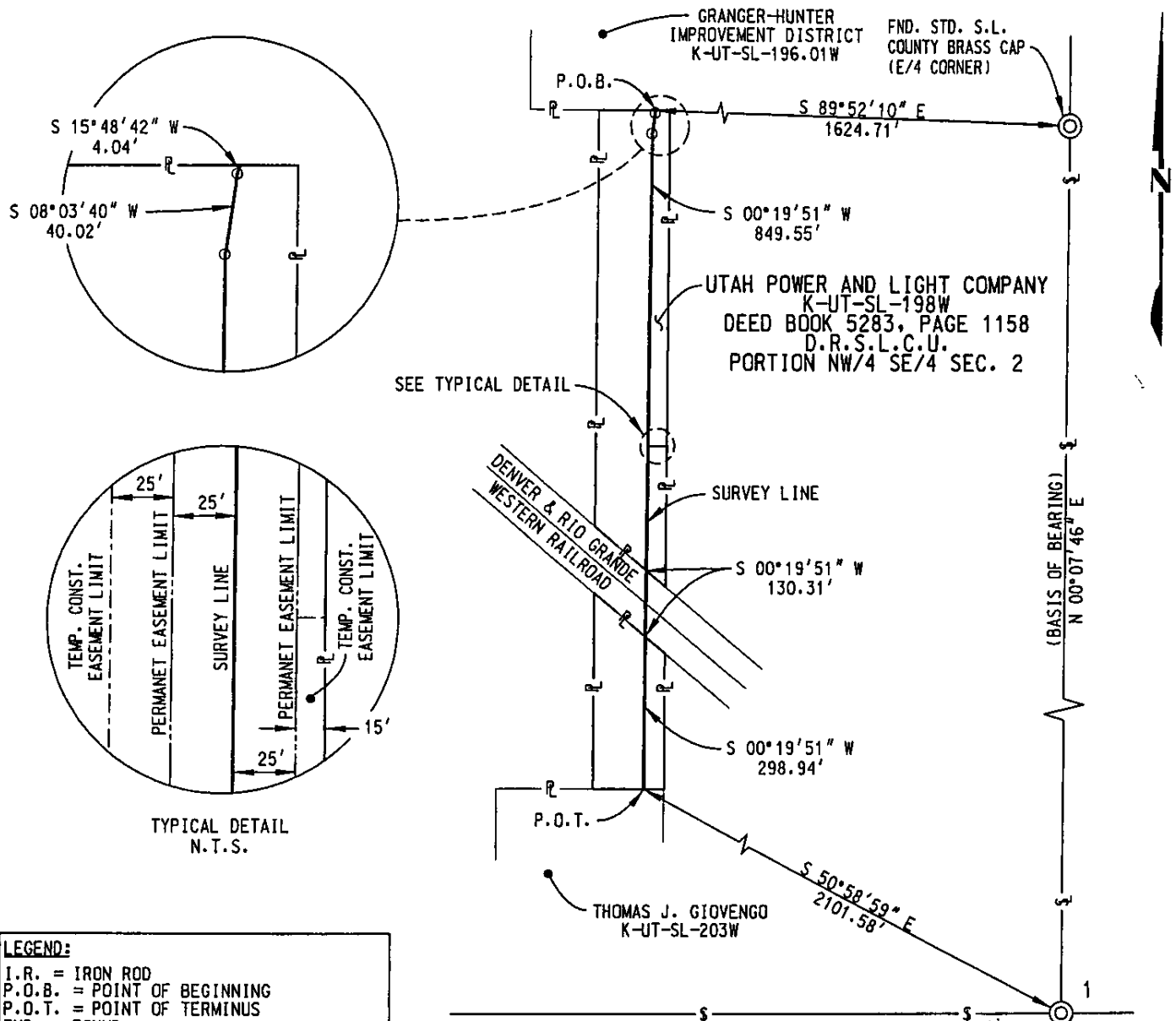

LEGEND:
 I.R. = IRON ROD
 P.O.B. = POINT OF BEGINNING
 P.O.T. = POINT OF TERMINUS
 FND. = FOUND
 K.R.G.T. = KERN RIVER GAS TRANSMISSION
 P/L = PIPELINE
 SPC = STATE COORDINATES SYSTEM
 NAD = NORTH AMERICAN DATUM
 D.R.S.L.C.U. = DEED RECORDS OF SALT LAKE COUNTY, UTAH

- NOTES:**
1. BEARINGS AND DISTANCES ARE BASED ON THE "UTAH COORDINATE SYSTEM 1983 CENTRAL ZONE", DERIVED FROM GPS METHODS. SCALE FACTOR OF 0.999742630 APPLIED TO RODDAGE AND ACREAGE.
 2. BASIS OF BEARING EAST LINE OF SECTION 2 BEING N 00°07'46" E
 3. EASEMENT SURVEY AUGUST 2001.
 4. PREPARED BY: UNIVERSAL ENSCO, INC. 1811 BERING DR. HOUSTON, TX. 77057



FND. STD. S.L. COUNTY BRASS CAP

I HEREBY CERTIFY THAT THIS PLAT IS A TRUE REPRESENTATION OF A SURVEY MADE BY ME OR UNDER MY DIRECT SUPERVISION.

Gary Henry Greer
 GARY HENRY GREER P.L.S. #373234
 PROFESSIONAL LAND SURVEYOR

DRAWING NO.		REFERENCE TITLE		KERN RIVER GAS TRANSMISSION COMPANY PROPERTY PLAT PERMANENT, TEMPORARY CONST. & A.T.W.S. EASEMENTS CROSSING PROPERTY OF UTAH POWER AND LIGHT COMPANY T 2 S - R 2 W, SECTION 2 SALT LAKE COUNTY, UTAH						
NO.	DATE	BY	REVISION DESCRIPTION	W.O. NO.	CHK.	APP.	DRAWN BY: UET	DATE: 03-22-2002	ISSUED FOR BID:	SCALE: 1" = 300'
01	08-06-02	UET	CHANGED TEMPORARY CONSTRUCTION AND A.T.W.S. EASEMENTS				CHECKED BY: UET	DATE: 03-22-2002	ISSUED FOR CONSTRUCTION:	
							APPROVED BY:	DATE:	DRAWING NUMBER: K-UT-SL-198W	SHEET 1 OF 1

BK 8661 PG 7661

EXHIBIT "I"

UTAH POWER AND LIGHT COMPANY
SALT LAKE COUNTY, UTAH
L.L. No. K-UT-SL-201.01W
SHEET 1 OF 1

PERMANENT EASEMENT

Being a permanent easement extending over, through and across a portion of a certain tract conveyed to Utah Power and Light Company, and being located in a portion of the West Half of the Southeast Quarter of Section 2, Township 2 South, Range 2 West, Salt Lake Base and Meridian, Salt Lake County, Utah. Said tract being more particularly described in Deed Book 2038, Page 367 of the Deed Records of Salt Lake County, Utah, said temporary construction easement being more particularly described by metes and bounds as follows:

Beginning at the intersection of the West line of said tract and the South line of said Section 2, from which a standard Salt Lake County Brass Cap found marking the South Quarter corner of said Section 2 bears North 89°53'39" West, a distance of 1063.93 feet;

THENCE North 00°05'21" East, a distance of 779.98 feet along West line of said tract to a point;

THENCE South 14°43'21" East, a distance of 66.54 feet to a point;

THENCE South 07°12'31" East, a distance of 41.99 feet to a point;

THENCE South 00°17'42" West, a distance of 674.01 feet to a point on the South line of said Section 2;

THENCE South 89°53'39" West, a distance of 19.92 feet along the South line of said Section 2 to the point of beginning. Said easement contains 0.58 acres of land, less and except land of others (railroad right-of-way).

BK8661 PG7662

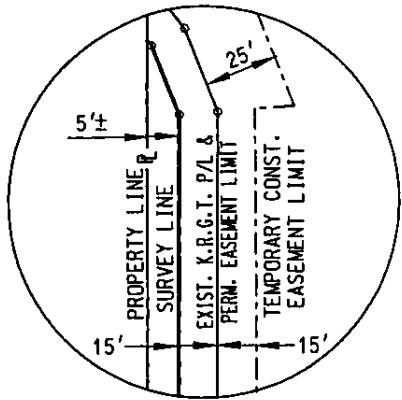

DETAIL A
N.T.S.

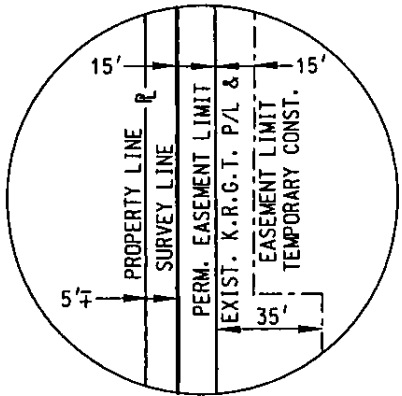

DETAIL B
N.T.S.

UTAH POWER AND LIGHT COMPANY
K-UT-SL-201.01W
DEED BOOK 2038, PAGE 367
D.R.S.L.C.U.
PORTION W/2 SE/4 SEC. 2

THOMAS J. GIOVENGO
K-UT-SL-203W

FND. STD. S.L.
COUNTY BRASS CAP
(S/4 COR.)

4700 SOUTH STREET

S 55°57'54" W
1285.21'

N 89°53'39" W
1068.85'

S 00°17'42" W
345.88'

S 00°17'42" W
50.05'

S 00°17'42" W
277.14'

S 14°43'21" E
8.83'

S 07°12'31" E
40.02'

SEE DETAIL "A"

EXISTING
K.R.G.T. P/L

SEE DETAIL "B"

DENVER & RIO
GRANDE WESTERN
SPUR TRACK

SEE TYPICAL
DETAIL

(BASIS OF BEARING)
N 00°07'46" E

LEGEND:

- I.R. = IRON ROD
- P.O.B. = POINT OF BEGINNING
- P.O.T. = POINT OF TERMINUS
- FND. = FOUND
- K.R.G.T. = KERN RIVER GAS TRANSMISSION
- P/L = PIPELINE
- SPC = STATE COORDINATES SYSTEM
- NAD = NORTH AMERICAN DATUM
- D.R.S.L.C.U. = DEED RECORDS OF SALT LAKE COUNTY, UTAH

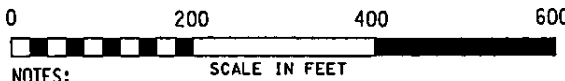

NOTES:

1. BEARINGS AND DISTANCES ARE BASED ON THE "UTAH COORDINATE SYSTEM 1983 CENTRAL ZONE", DERIVED FROM GPS METHODS. SCALE FACTOR OF 0.999742630 APPLIED TO RODDAGE AND ACREAGE.
2. BASIS OF BEARING EAST LINE OF SECTION 2 BEING N 00°07'46" E
3. EASEMENT SURVEY AUGUST 2001.
4. PREPARED BY: UNIVERSAL ENSCO, INC. 1811 BERING DR. HOUSTON, TX. 77057

FND. STD. S.L. COUNTY BRASS CAP
UTAH POWER AND LIGHT COMPANY
K-UT-SL-201.01W
I HEREBY CERTIFY THAT THIS PLAT IS A TRUE REPRESENTATION OF A SURVEY MADE BY ME OR UNDER MY DIRECT SUPERVISION.
GARY HENRY GREER PLS #373234
PROFESSIONAL LAND SURVEYOR

DRAWING NO.	REFERENCE TITLE

KERN RIVER GAS TRANSMISSION COMPANY
PROPERTY PLAT
PERMANENT, TEMP. CONSTRUCTION & A.T.W.S. EASEMENTS
CROSSING PROPERTY OF
UTAH POWER AND LIGHT COMPANY
T 2 S - R 2 W, SECTION 2
SALT LAKE COUNTY, UTAH

Williams
GAS PIPELINE

NO.	DATE	BY	REVISION DESCRIPTION	W.O. NO.	CHK.	APP.	DRAWN BY:	DATE:	ISSUED FOR:	SCALE:
1	07-10-2002	UE1	REVISE EASEMENTS				UE1	04-16-2002	BID	1" = 200'
2	08-05-2002	UE1	REVISE TEMPORARY CONSTRUCTION EASEMENTS AND A.T.W.S.				UE1	04-16-2002	CONSTRUCTION	
APPROVED BY:							DATE:	DRAWING NUMBER: K-UT-SL-201.01W		SHEET 1 OF 2

BK 8661 PG 7663

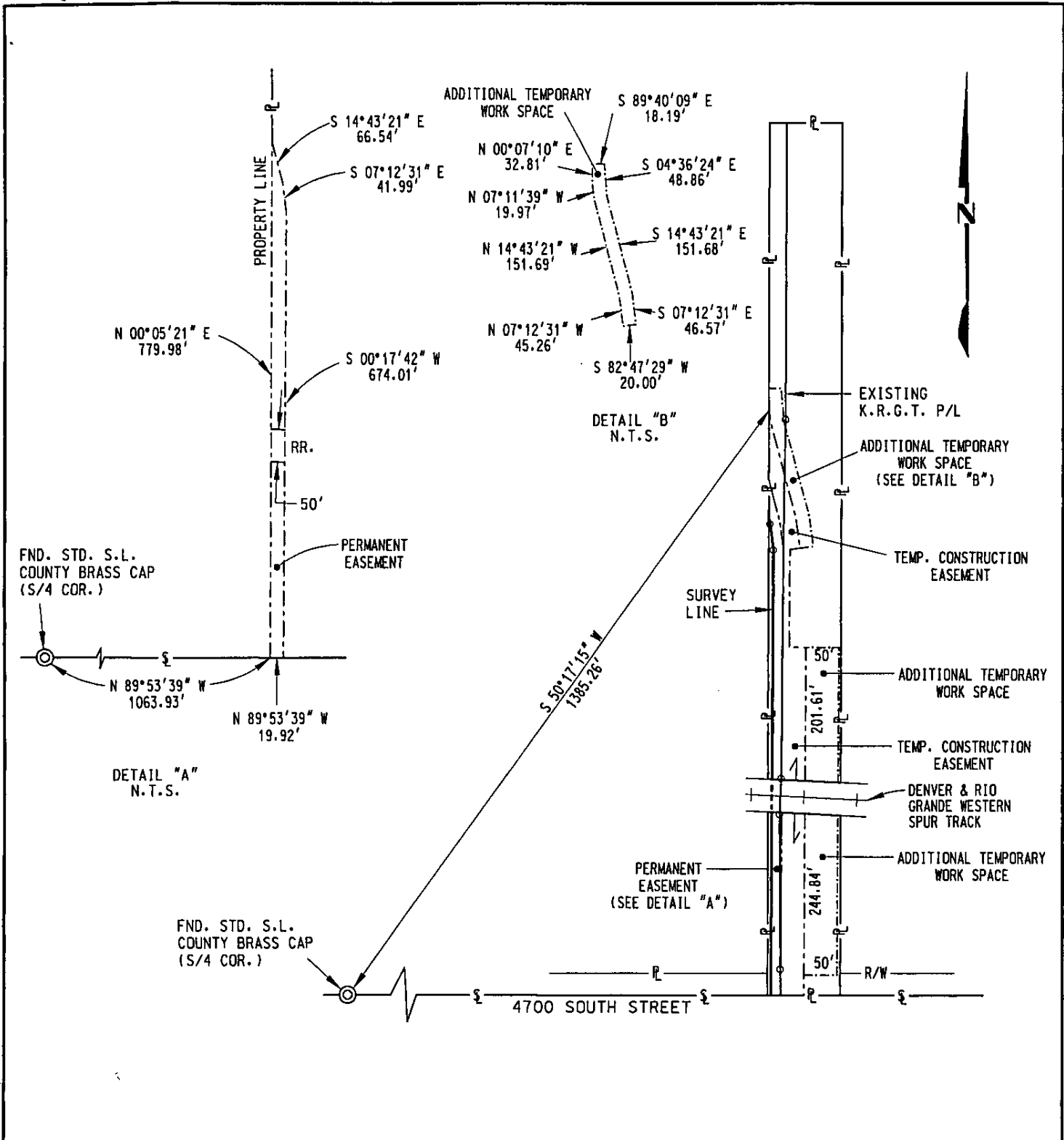

DRAWING NO.		REFERENCE TITLE		KERN RIVER GAS TRANSMISSION COMPANY PROPERTY PLAT PERMANENT, TEMP. CONSTRUCTION & A.T.W.S. EASEMENTS CROSSING PROPERTY OF UTAH POWER AND LIGHT COMPANY T 2 S - R 2 W, SECTION 2 SALT LAKE COUNTY, UTAH						
NO.	DATE	BY	REVISION DESCRIPTION	W.O. NO.	CHK.	APP.	DRAWN BY: UE1	DATE: 04-16-2002	ISSUED FOR BID:	SCALE: N.T.S.
1	07-10-2002	UE1	REVISE EASEMENTS				CHECKED BY: UE1	DATE: 04-16-2002	ISSUED FOR CONSTRUCTION:	
2	08-05-2002	UE1	REVISE TEMPORARY CONSTRUCTION EASEMENTS AND A.T.W.S.				APPROVED BY:	DATE:	DRAWING NUMBER: K-UT-SL-201.01W	SHEET 2 OF 2

BK8661PG7664

EXHIBIT "J"

UTAH POWER AND LIGHT COMPANY
SALT LAKE COUNTY, UTAH
L.L. No. K-UT-SL-205.01W
SHEET 1 OF 1

PERMANENT EASEMENT

A permanent easement extending over, through and across a portion of a certain tract conveyed to Utah Power and Light Company, and being located in a portion of the West Half of the Northeast Quarter of Section 11, Township 2 South, Range 2 West, Salt Lake Base and Meridian, Salt Lake County, Utah. Said tract being more particularly described in Deed Book 5863, Page 2956 of the Deed Records of Salt Lake County, Utah, said temporary construction easement being more particularly described by metes and bounds as follows:

Beginning at the intersection of the Southerly right-of way of 4700 South Street and the West line of said tract, from which a standard Salt Lake County Brass Cap found marking the North Quarter corner of said Section 11 bears North $88^{\circ}06'50''$ West, a distance of 1062.23 feet;

THENCE South $89^{\circ}53'39''$ East, a distance of 22.03 feet to a point;

THENCE South $00^{\circ}17'42''$ West, a distance of 489.72 feet to a point;

THENCE South $07^{\circ}47'09''$ West, a distance of 41.98 feet to a point;

THENCE South $15^{\circ}16'54''$ West, a distance of 55.41 feet to a point on the West line of said tract;

THENCE North $00^{\circ}04'37''$ East, a distance of 584.40 feet along said West line of said tract to the point of beginning. Said permanent easement contains 0.26 acres of land.

BK8661 PG7665

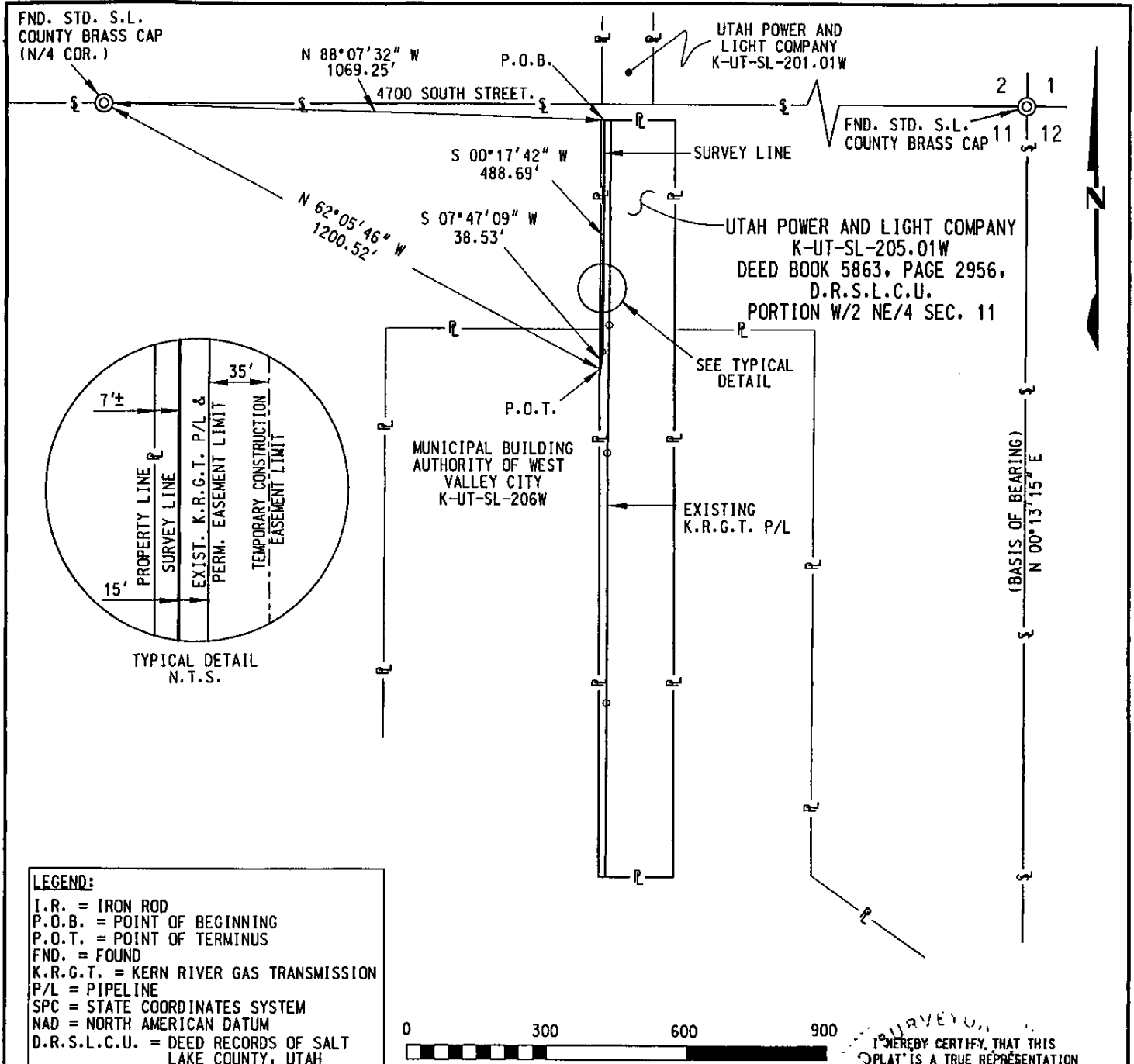

LEGEND:
 I.R. = IRON ROD
 P.O.B. = POINT OF BEGINNING
 P.O.T. = POINT OF TERMINUS
 FND. = FOUND
 K.R.G.T. = KERN RIVER GAS TRANSMISSION
 P/L = PIPELINE
 SPC = STATE COORDINATES SYSTEM
 NAD = NORTH AMERICAN DATUM
 D.R.S.L.C.U. = DEED RECORDS OF SALT LAKE COUNTY, UTAH

- NOTES:**
- BEARINGS AND DISTANCES ARE BASED ON THE "UTAH COORDINATE SYSTEM 1983 CENTRAL ZONE", DERIVED FROM GPS METHODS. SCALE FACTOR OF 0.999742630 APPLIED TO RODDAGE AND ACREAGE.
 - BASIS OF BEARING EAST LINE OF SECTION 11 BEING N 00°13'15" E
 - EASEMENT SURVEY AUGUST 2001.
 - PREPARED BY: UNIVERSAL ENSCO, INC. 1811 BERING DR. HOUSTON, TX. 77057

I HEREBY CERTIFY, THAT THIS PLAT IS A TRUE REPRESENTATION OF A SURVEY MADE BY ME, OR UNDER MY DIRECT SUPERVISION.

Gary Henry Greer
 GARY HENRY GREER PLS. #373234
 PROFESSIONAL LAND SURVEYOR

DRAWING NO.		REFERENCE TITLE		KERN RIVER GAS TRANSMISSION COMPANY PROPERTY PLAT PERMANENT, TEMP. CONSTRUCTION & A.T.W.S. EASEMENTS CROSSING PROPERTY OF UTAH POWER AND LIGHT COMPANY T 2 S - R 2 W, SECTION 11 SALT LAKE COUNTY, UTAH						
NO.	DATE	BY	REVISION DESCRIPTION	W.O. NO.	CHK.	APP.	DRAWN BY:	DATE:	ISSUED FOR BID:	SCALE:
1	07-10-2002	UE1	REVISE EASEMENTS				UE1	04-16-2002		1" = 300'
2	08-06-2002	UE1	REVISE A.T.W.S.				UE1	04-16-2002	ISSUED FOR CONSTRUCTION:	
							APPROVED BY:	DATE:	DRAWING NUMBER: K-UT-SL-205.01W	
									SHEET 1 OF 2	

BR8661PG7666

FND. STD. S.L.
COUNTY BRASS CAP
(N/4 COR.)

FND. STD. S.L.
COUNTY BRASS CAP
(N/4 COR.)

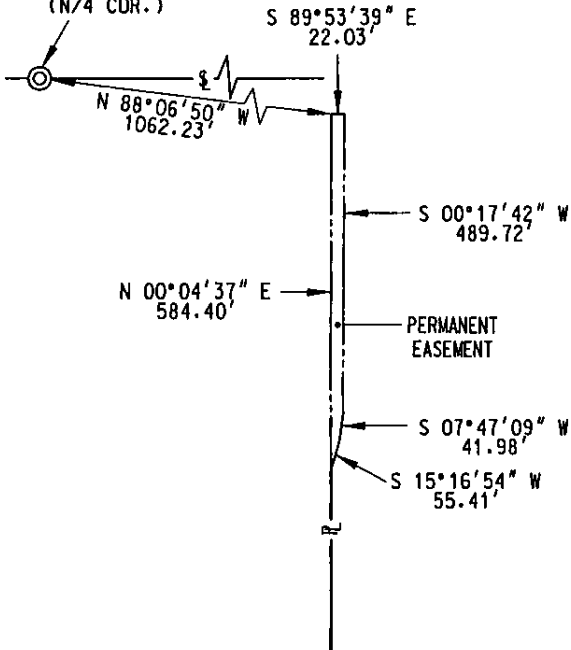

DETAIL "A"
N.T.S.

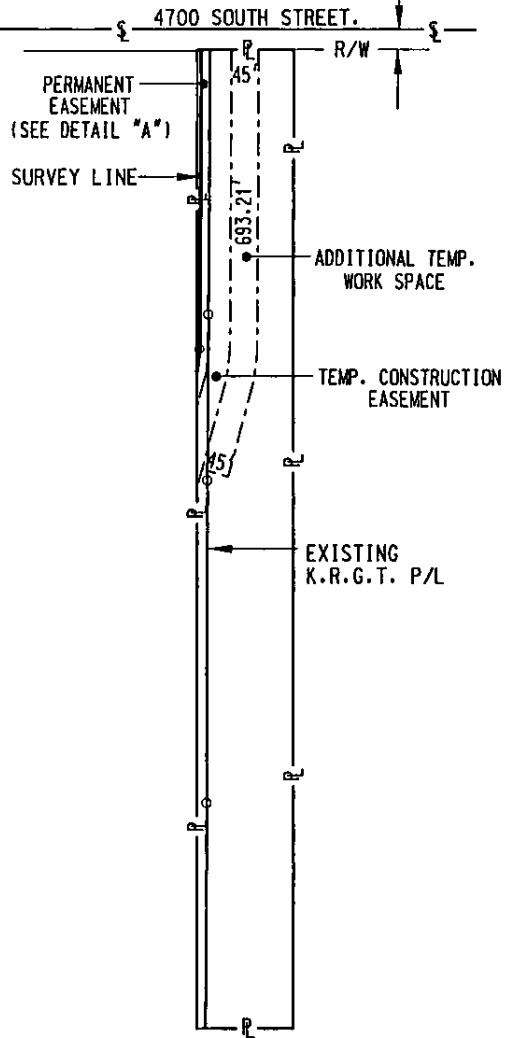

LEGEND:

- I.R. = IRON ROD
- P.O.B. = POINT OF BEGINNING
- P.O.T. = POINT OF TERMINUS
- FND. = FOUND
- K.R.G.T. = KERN RIVER GAS TRANSMISSION
- P/L = PIPELINE
- SPC = STATE COORDINATES SYSTEM
- NAD = NORTH AMERICAN DATUM
- D.R.S.L.C.U. = DEED RECORDS OF SALT LAKE COUNTY, UTAH



NOTES:

1. BEARINGS AND DISTANCES ARE BASED ON THE "UTAH COORDINATE SYSTEM 1983 CENTRAL ZONE", DERIVED FROM GPS METHODS. SCALE FACTOR OF 0.999742630 APPLIED TO RODDAGE AND ACREAGE.
2. BASIS OF BEARING EAST LINE OF SECTION 11 BEING N 00°13'15" E
3. EASEMENT SURVEY AUGUST 2001.
4. PREPARED BY: UNIVERSAL ENSCO, INC. 1811 BERING DR. HOUSTON, TX. 77057

DRAWING NO.		REFERENCE TITLE			KERN RIVER GAS TRANSMISSION COMPANY PROPERTY PLAT PERMANENT, TEMP. CONSTRUCTION & A.T.W.S. EASEMENTS CROSSING PROPERTY OF UTAH POWER AND LIGHT COMPANY T 2 S - R 2 W, SECTION 11 SALT LAKE COUNTY, UTAH					
NO.	DATE	BY	REVISION DESCRIPTION	W.O. NO.	CHK.	APP.	DRAWN BY: UEI	DATE: 04-16-2002	ISSUED FOR BID:	SCALE: N.T.S.
1	07-10-2002	UEI	REVISE EASEMENTS				CHECKED BY: UEI	DATE: 04-16-2002	ISSUED FOR CONSTRUCTION:	
2	08-06-2002	UEI	REVISE A.T.W.S.				APPROVED BY:	DATE:	DRAWING NUMBER: K-UT-SL-205.01W	SHEET 2 OF 2

BK8661PG7667

UTAH POWER AND LIGHT COMPANY
SALT LAKE COUNTY, UTAH
L.L. No. K-UT-SL-208-209W
SHEET 2 OF 2

THENCE South $00^{\circ}32'26''$ West, a distance of 173.99 feet to a point of terminus on the South line of said tract, from which a Standard Salt Lake County Brass Cap found marking the Southeast Quarter of said Section 11 bears South $89^{\circ}24'26''$ East, a distance of 1695.32 feet, said easement being 162.25 rods in length and contains 2.97 acres of land.

BK8661PG7668

EXHIBIT "K"

UTAH POWER AND LIGHT COMPANY
SALT LAKE COUNTY, UTAH
L.L. No. K-UT-SL-208-209W
SHEET 1 OF 2

A PERMANENT EASEMENT

Being a fifty (50) foot wide permanent easement lying twenty five (25) feet Westerly and twenty five (25) feet Easterly of the following described Survey line to a point of convergence whereas the herein described easement changes to a twenty five (25) foot wide permanent easement lying twenty (25) feet Westerly of the following described Survey line to a point of convergence whereas the herein described easement changes to a fifty (50) foot wide permanent easement lying twenty (25) feet Westerly and twenty five (25) feet Easterly of the following described Survey line to a point of convergence whereas the herein described easement changes to a twenty five (25) foot wide permanent easement lying twenty five (25) feet Westerly of the following described Survey line, also following an existing Kern River 36" pipeline.

Said fifty (50) foot and twenty five (25) foot wide permanent easements extending over, through and across a portion of a certain tract conveyed to Utah Power and Light Company, and being located in Section 11, Township 2 South, Range 21 West, Salt Lake Base and Meridian, Salt Lake County, Utah. Said tract being more particularly described in Deed Book 6355, Page 1415 and Book 6355, Page 1420 of the Deed Records of Salt Lake County, Utah, said Survey line being more particularly described as follows:

Beginning at a point on the North line of said tract, from which a Standard Salt Lake County Brass Cap found marking the South Quarter corner of said Section 11, bears South 21°21'50" West, a distance of 2823.78 feet;

THENCE South 00°19'34" West, a distance of 1198.81 feet to a point;

THENCE South 44°39'49" East, a distance of 56.63 feet to a point;

THENCE South 00°27'37" West, a distance of 600.01 feet to a point;

THENCE South 45°25'52" West, a distance of 54.53 feet to a point;

THENCE South 00°19'27" West, a distance of 323.58 feet to a point;

THENCE South 11°43'45" West, a distance of 225.51 feet to a point;

THENCE South 00°32'26" West, a distance of 44.07 feet to a point of convergence whereas said fifty (50) foot wide permanent easement ends and said twenty five (25) foot wide permanent easement begins of the herein continued description of said Survey line;

BK86661 PG7669

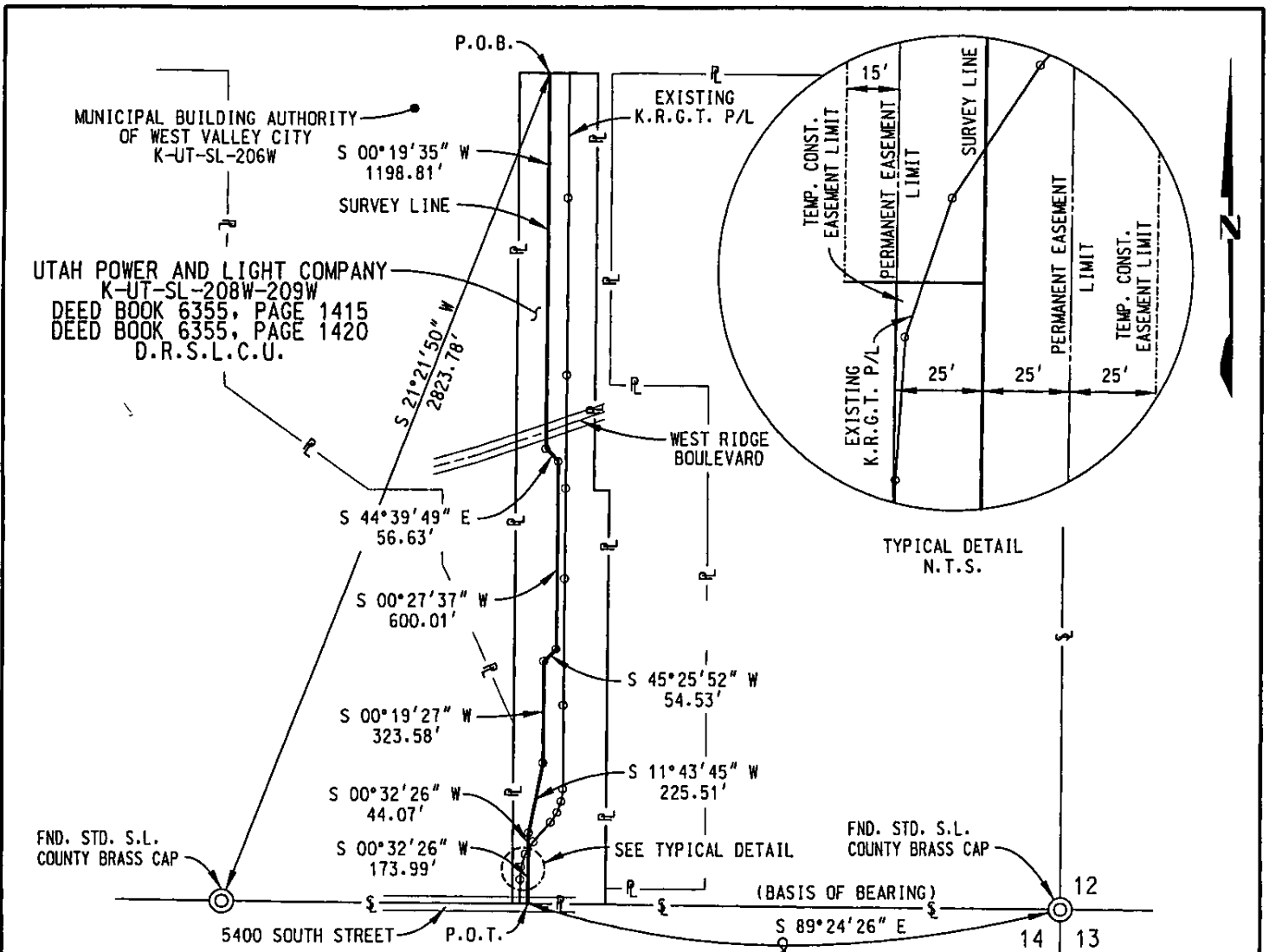

LEGEND:
 I.R. = IRON ROD
 P.O.B. = POINT OF BEGINNING
 P.O.T. = POINT OF TERMINUS
 FND. = FOUND
 K.R.G.T. = KERN RIVER GAS TRANSMISSION
 P/L = PIPELINE
 SPC = STATE COORDINATES SYSTEM
 NAD = NORTH AMERICAN DATUM
 D.R.S.L.C.U. = DEED RECORDS OF SALT LAKE COUNTY, UTAH

- NOTES:**
- BEARINGS AND DISTANCES ARE BASED ON THE "UTAH COORDINATE SYSTEM 1983 CENTRAL ZONE", DERIVED FROM GPS METHODS. SCALE FACTOR OF 0.999742630 APPLIED TO RODDAGE AND ACREAGE.
 - BASIS OF BEARING SOUTH LINE OF SECTION 11 BEING S 89°24'26" E
 - EASEMENT SURVEY AUGUST 2001.
 - PREPARED BY: UNIVERSAL ENSCO, INC. 1811 BERING DR. HOUSTON, TX. 77057



LAND SURVEYOR
 I HEREBY CERTIFY THAT THIS PLAT IS A TRUE REPRESENTATION OF A SURVEY MADE BY ME OR UNDER MY DIRECT SUPERVISION.
 GARY HENRY GREER PLS #373234
 PROFESSIONAL LAND SURVEYOR

DRAWING NO.		REFERENCE TITLE		KERN RIVER GAS TRANSMISSION COMPANY PROPERTY PLAT PERMANENT, TEMPORARY CONST. & A.T.W.S. EASEMENTS CROSSING PROPERTY OF UTAH POWER AND LIGHT COMPANY T 2 S - R 2 W, SECTION 11 SALT LAKE COUNTY, UTAH						
NO.	DATE	BY	REVISION DESCRIPTION	W.O. NO.	CHK.	APP.	DRAWN BY: UEI	DATE: 03-28-2002	ISSUED FOR BID:	SCALE: 1" = 500'
01	5-28-02	UEI	CHANGED SURVEY LINE PER LINE CHANGE				CHECKED BY: UEI	DATE: 03-28-2002	ISSUED FOR CONSTRUCTION:	
02	8-07-02	UEI	CHANGED PERMANENT, TEMP. CONST. & A.T.W.S. EASEMENTS				APPROVED BY:	DATE:	DRAWING NUMBER: K-UT-SL-208-209W	SHEET 1 OF 1

BK8661PG7670

EXHIBIT "L"

UTAH POWER AND LIGHT COMPANY
SALT LAKE COUNTY, UTAH
L.L. No. K-UT-SL-212W
SHEET 1 OF 2

A PERMANENT EASEMENT

Being a twenty five (25) foot wide permanent easement lying twenty five (25) feet Easterly of the following described Survey line to a point of convergence whereas the herein described easement changes to a fifty (50) foot wide permanent easement lying twenty five (25) feet Westerly and twenty five (25) feet Easterly of the following described Survey line to a point of convergence whereas the herein described easement changes to a twenty five (25) foot wide permanent easement lying twenty five (25) feet Easterly, also following an existing Kern River 36" pipeline.

Said permanent easement extending over, through and across a portion of a certain tract conveyed to Utah Power and Light Company, and being located in a portion of the West Half of the East Half of Section 14, Township 2 South, Range 2 West, Salt Lake Base and Meridian, Salt Lake County, Utah. Said tract being more particularly described in Deed Book 1984, Page 593, Book 1985, Page 590, Deed Book 4800, Page 1103, Deed Book 5055, Page 430 and Book 5283, Page 708 of the Deed Records of Salt Lake County, Utah, said Survey line being more particularly described as follows:

Beginning at a point on the North line of said tract, from which a Standard Salt Lake County Brass Cap found marking the North Quarter corner of said Section 14 bears North 86°16'28" West, a distance of 969.79 feet;

THENCE South 00°32'26" West, a distance of 356.44 feet to a point;

THENCE South 08°32'29" East, a distance of 40.00 feet to a point;

THENCE South 17°38'16" East, a distance of 40.01 feet to a point;

THENCE South 26°43'31" East, a distance of 83.20 feet to a point of convergence whereas said twenty five (25) foot wide permanent easement ends and said fifty (50) foot wide permanent easement begins of the herein continued description of said Survey line;

THENCE South 26°43'31" East, a distance of 91.16 feet to a point;

THENCE South 17°41'48" East, a distance of 40.01 feet to a point;

THENCE South 08°41'07" East, a distance of 40.01 feet to a point;

THENCE South 00°20'35" West, a distance of 698.98 feet to a point on the North line of land of others;

BK8661PG7671

UTAH POWER AND LIGHT COMPANY (Continued)
SALT LAKE COUNTY, UTAH
L.L. No. K-UT-SL-212W

SHEET 2 OF 2 THENCE South $00^{\circ}20'35''$ West, a distance of 60.16 feet to a point on the South line of land of others;

THENCE South $00^{\circ}20'35''$ West, a distance of 2391.96 feet to a point on the North line of land of others;

THENCE South $00^{\circ}20'35''$ West, a distance of 73.75 feet to a point on the South line of land of others;

THENCE South $00^{\circ}20'35''$ West, a distance of 667.20 feet to a point;

THENCE South $08^{\circ}25'26''$ West, a distance of 40.01 feet to a point;

THENCE South $16^{\circ}28'08''$ West, a distance of 40.01 feet to a point;

THENCE South $24^{\circ}32'44''$ West, a distance of 150.18 feet to a point;

THENCE South $16^{\circ}25'39''$ West, a distance of 40.00 feet to a point;

THENCE South $08^{\circ}17'32''$ West, a distance of 40.02 feet to a point of convergence whereas said fifty (50) foot wide permanent easement ends and said twenty five (25) foot wide permanent easement begins of the herein continued description of said Survey line;

THENCE South $00^{\circ}10'25''$ West, a distance of 347.53 feet to the point of terminus on the South line of said tract, from which a Standard Salt Lake County Brass Cap found marking the South Quarter corner of said Section 14 bears South $87^{\circ}53'34''$ West, a distance of 969.16 feet, said easement being 309.50 rods in length and contains 5.36 acres of land, less and except lands of others.

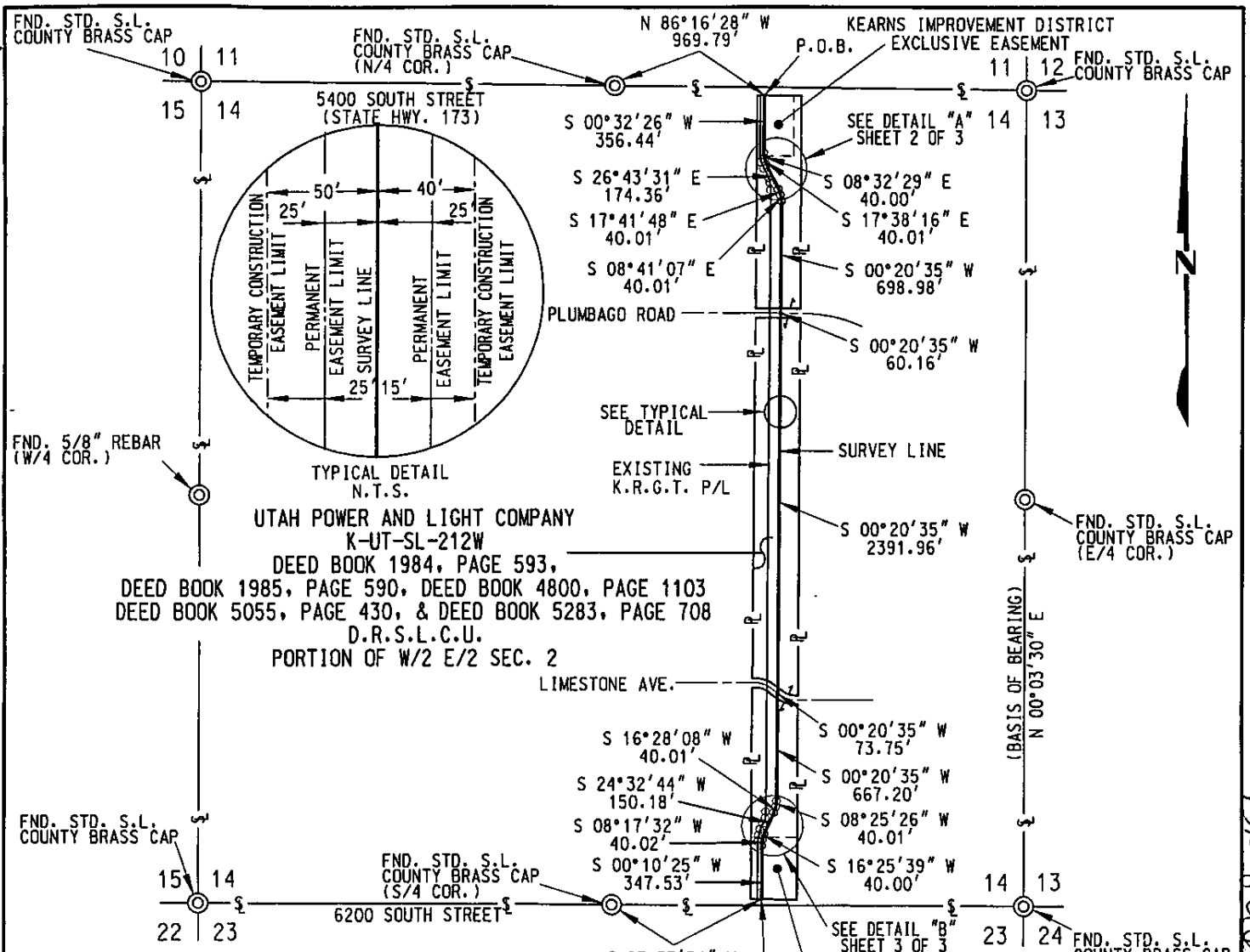

UTAH POWER AND LIGHT COMPANY
 K-UT-SL-212W
 DEED BOOK 1985, PAGE 590, DEED BOOK 4800, PAGE 1103
 DEED BOOK 5055, PAGE 430, & DEED BOOK 5283, PAGE 708
 D.R.S.L.C.U.
 PORTION OF W/2 E/2 SEC. 2

LEGEND:
 I.R. = IRON ROD
 P.O.B. = POINT OF BEGINNING
 P.O.T. = POINT OF TERMINUS
 FND. = FOUND
 K.R.G.T. = KERN RIVER GAS TRANSMISSION
 P/L = PIPELINE
 SPC = STATE COORDINATES SYSTEM
 NAD = NORTH AMERICAN DATUM
 D.R.S.L.C.U. = DEED RECORDS OF SALT LAKE COUNTY, UTAH

- NOTES:**
- BEARINGS AND DISTANCES ARE BASED ON THE "UTAH COORDINATE SYSTEM 1983 CENTRAL ZONE", DERIVED FROM GPS METHODS. SCALE FACTOR OF 0.999742630 APPLIED TO RODDAGE AND ACREAGE.
 - BASIS OF BEARING EAST LINE OF SECTION 14 BEING N 00°03'30" E
 - EASEMENT SURVEY AUGUST 2001.
 - PREPARED BY: UNIVERSAL ENSCO, INC. 1811 BERING DR. HOUSTON, TX. 77057

PROFESSIONAL SURVEYOR
 I HEREBY CERTIFY THAT THIS PLAT IS A TRUE REPRESENTATION OF A SURVEY MADE BY ME OR UNDER MY DIRECT SUPERVISION.
 GARY HENRY GREER PLS #373204
 PROFESSIONAL LAND SURVEYOR

DRAWING NO.		REFERENCE TITLE		KERN RIVER GAS TRANSMISSION COMPANY PROPERTY PLAT PERMANENT, TEMPORARY CONST. & A.T.W.S. EASEMENTS CROSSING PROPERTY OF UTAH POWER AND LIGHT COMPANY T 2 S - R 2 W, SECTION 14 SALT LAKE COUNTY, UTAH						
NO.	DATE	BY	REVISION DESCRIPTION	W.O. NO.	CHK.	APP.	DRAWN BY: UEI	DATE: 04-01-2002	ISSUED FOR BID:	SCALE: 1" = 1000'
1	7-15-02	UEI	REVISED EASEMENTS				CHECKED BY: UEI	DATE: 04-01-2002	ISSUED FOR CONSTRUCTION:	
2	8-07-02	UEI	REVISED EASEMENTS				APPROVED BY:	DATE:	DRAWING NUMBER: K-UT-SL-212W	SHEET 1 OF 3

BK 8661 PG 7673

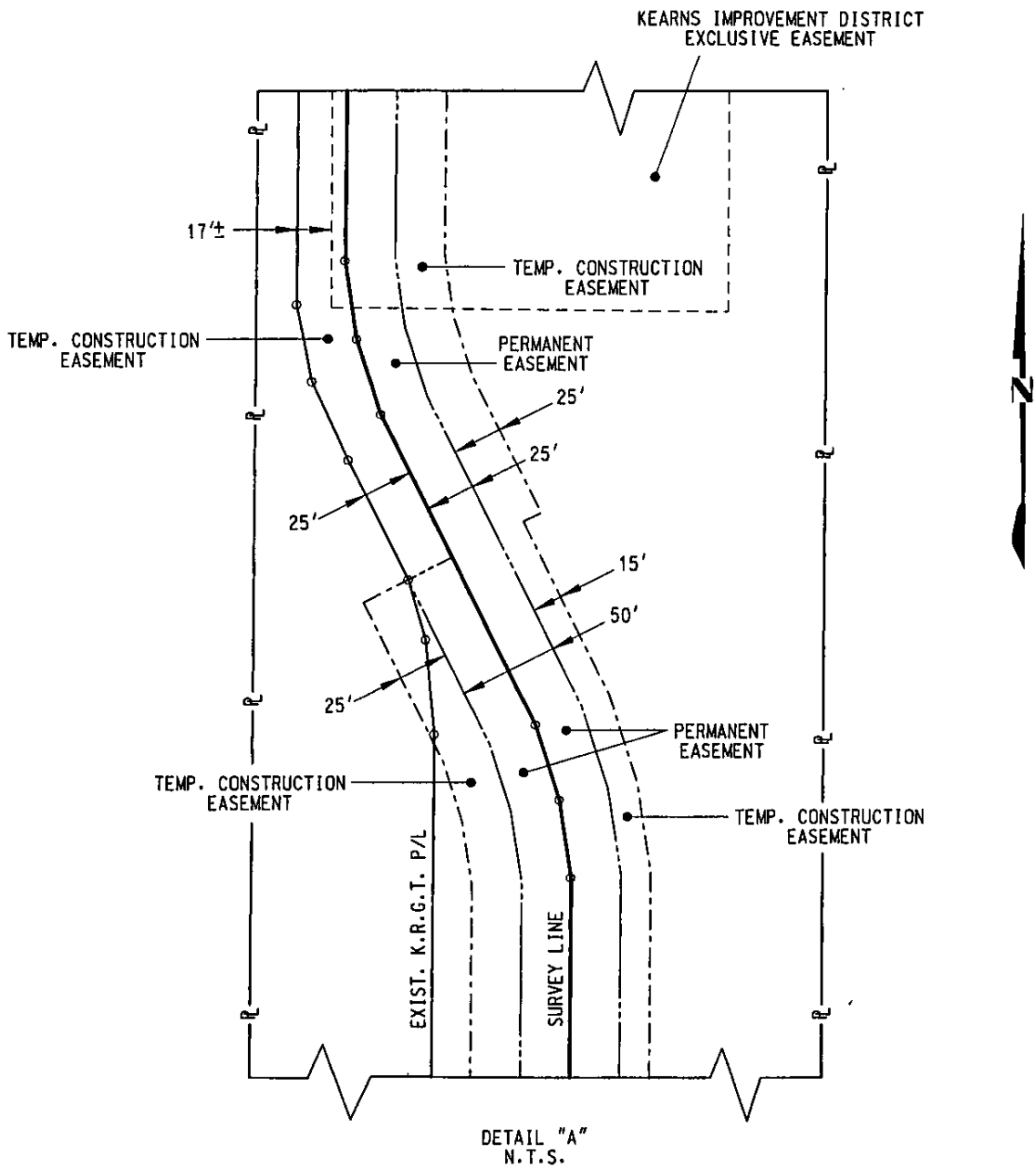

NOTES:

1. BEARINGS AND DISTANCES ARE BASED ON THE "UTAH COORDINATE SYSTEM 1983 CENTRAL ZONE", DERIVED FROM GPS METHODS. SCALE FACTOR OF 0.999742630 APPLIED TO RODDAGE AND ACREAGE.
2. BASIS OF BEARING EAST LINE OF SECTION 14 BEING N 00°03'30" E
3. EASEMENT SURVEY AUGUST 2001.
4. PREPARED BY: UNIVERSAL ENSCO, INC. 1811 BERING DR. HOUSTON, TX. 77057

DRAWING NO.		REFERENCE TITLE			KERN RIVER GAS TRANSMISSION COMPANY PROPERTY PLAT PERMANENT & TEMPORARY CONSTRUCTION EASEMENTS CROSSING PROPERTY OF UTAH POWER AND LIGHT COMPANY T 2 S - R 2 W, SECTION 14 SALT LAKE COUNTY, UTAH					
NO.	DATE	BY	REVISION DESCRIPTION	W.O. NO.	CHK.	APP.	DRAWN BY: UEI	DATE: 04-01-2002	ISSUED FOR BID:	SCALE: N.T.S.
1	7-15-02	UEI	REVISED EASEMENTS				CHECKED BY: UEI	DATE: 04-01-2002	ISSUED FOR CONSTRUCTION:	
1	8-07-02	UEI	REVISED EASEMENTS				APPROVED BY:	DATE:	DRAWING NUMBER: K-UT-SL-212W	SHEET 2 OF 3
									<small>XTIMEX ZPATHZ</small>	

BK 8661 PG 7674

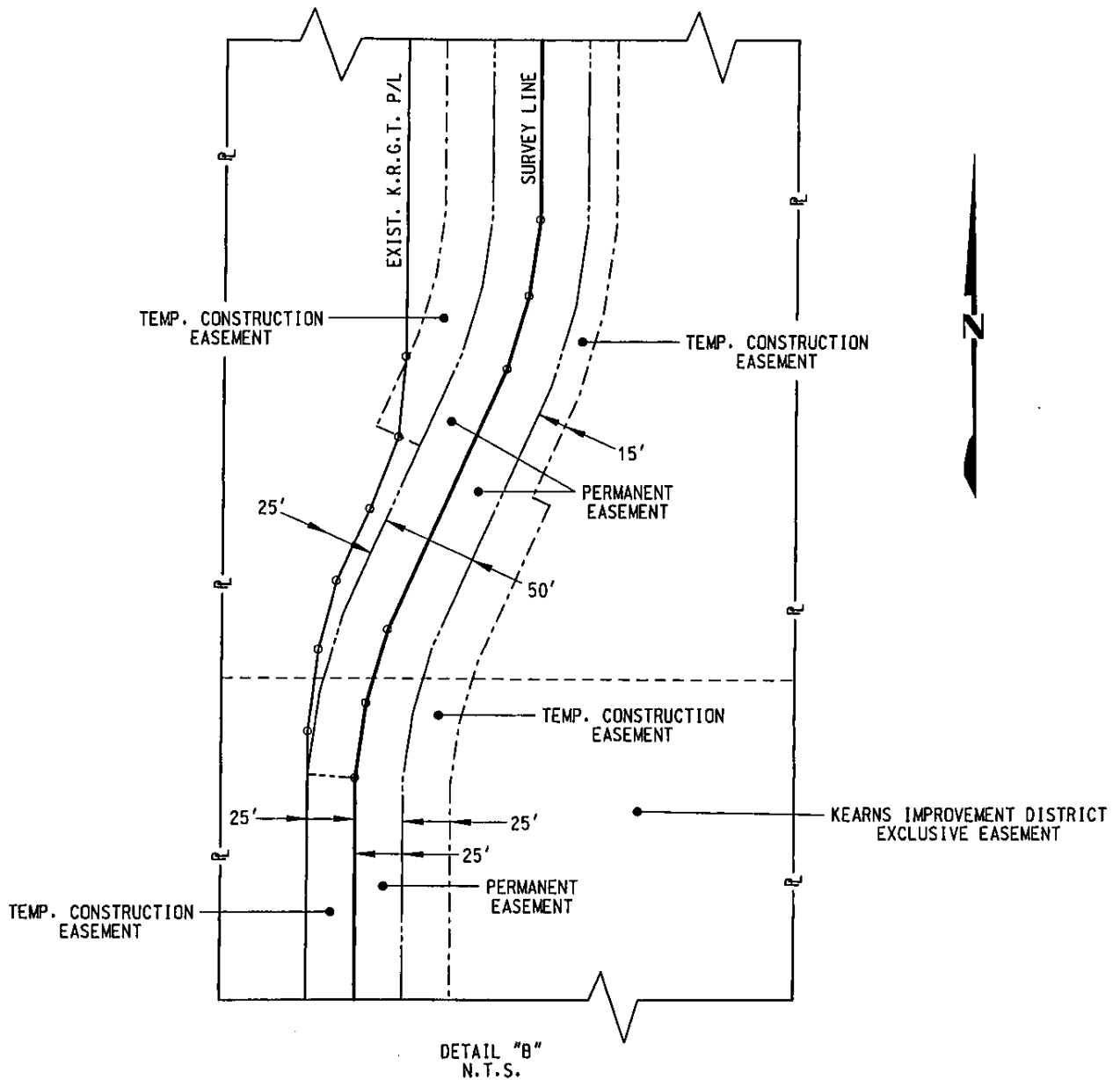

NOTES:

1. BEARINGS AND DISTANCES ARE BASED ON THE "UTAH COORDINATE SYSTEM 1983 CENTRAL ZONE", DERIVED FROM GPS METHODS. SCALE FACTOR OF 0.999742630 APPLIED TO RODDAGE AND ACREAGE.
2. BASIS OF BEARING EAST LINE OF SECTION 14 BEING N 00°03'30" E
3. EASEMENT SURVEY AUGUST 2001.
4. PREPARED BY: UNIVERSAL ENSCO, INC. 1811 BERING DR. HOUSTON, TX. 77057

DRAWING NO.		REFERENCE TITLE		KERN RIVER GAS TRANSMISSION COMPANY PROPERTY PLAT PERMANENT & TEMPORARY CONSTRUCTION EASEMENTS CROSSING PROPERTY OF UTAH POWER AND LIGHT COMPANY T 2 S - R 2 W, SECTION 14 SALT LAKE COUNTY, UTAH						
NO.	DATE	BY	REVISION DESCRIPTION	W.O. NO.	CHK.	APP.	DRAWN BY: UEI	DATE: 04-01-2002	ISSUED FOR BID:	SCALE: N.T.S.
1	7-15-02	UEI	REVISED EASEMENTS				CHECKED BY: UEI	DATE: 04-01-2002	ISSUED FOR CONSTRUCTION:	
1	8-07-02	UEI	REVISED EASEMENTS				APPROVED BY:	DATE:	DRAWING NUMBER: K-UT-SL-212W	SHEET 3 OF 3

BK 86661 PG 7675

EXHIBIT "M"

UTAH POWER AND LIGHT COMPANY
SALT LAKE COUNTY, UTAH
L.L. No. K-UT-SL-214W
SHEET 1 OF 1

A PERMANENT EASEMENT

Being a twenty five (25) foot wide permanent easement lying twenty five (25) feet Easterly of the following described Survey line to a point of convergence whereas the herein described easement changes to a fifty (50) foot wide permanent easement lying twenty five (25) feet Westerly and twenty five (25) feet Easterly of the following described Survey line, also following an existing Kern River 36" pipeline.

Said permanent easement extending over, through and across a portion of a certain tract conveyed to Utah Power and Light Company, and being located in a portion of the West Half of the East Half of Section 23, Township 2 South, Range 2 West, Salt Lake Base and Meridian, Salt Lake County, Utah. Said tract being more particularly described in Deed Book 1984, Page 590, Book 4471, Page 510 and Deed Book 4800, Page 1103 of the Deed Records of Salt Lake County, Utah, said Survey line being more particularly described as follows:

Beginning at a point on the North line of said Section 23, from which a Standard Salt Lake County Brass Cap found marking the North Quarter corner of said Section 23 bears North 89°44'30" West, a distance of 968.40 feet;

THENCE South 00°10'25" East, a distance of 64.49 feet to a point of convergence whereas said twenty five (25) foot wide permanent easement ends and said fifty (50) foot wide permanent easement begins of the herein continued description of said Survey line;

THENCE South 00°10'25" East, a distance of 66.25 feet to a point;

THENCE South 10°49'45" East, a distance of 119.20 feet to a point;

THENCE South 00°20'10" West, a distance of 3740.94 feet to the point of terminus on the South line of said tract, from which a Standard Salt Lake County Brass Cap found marking the South Quarter corner of said Section 23 bears South 36°42'03" West, a distance of 1659.23 feet, said easement being 241.87 rods in length and contains 4.54 acres of land.

BK8661 PG7676

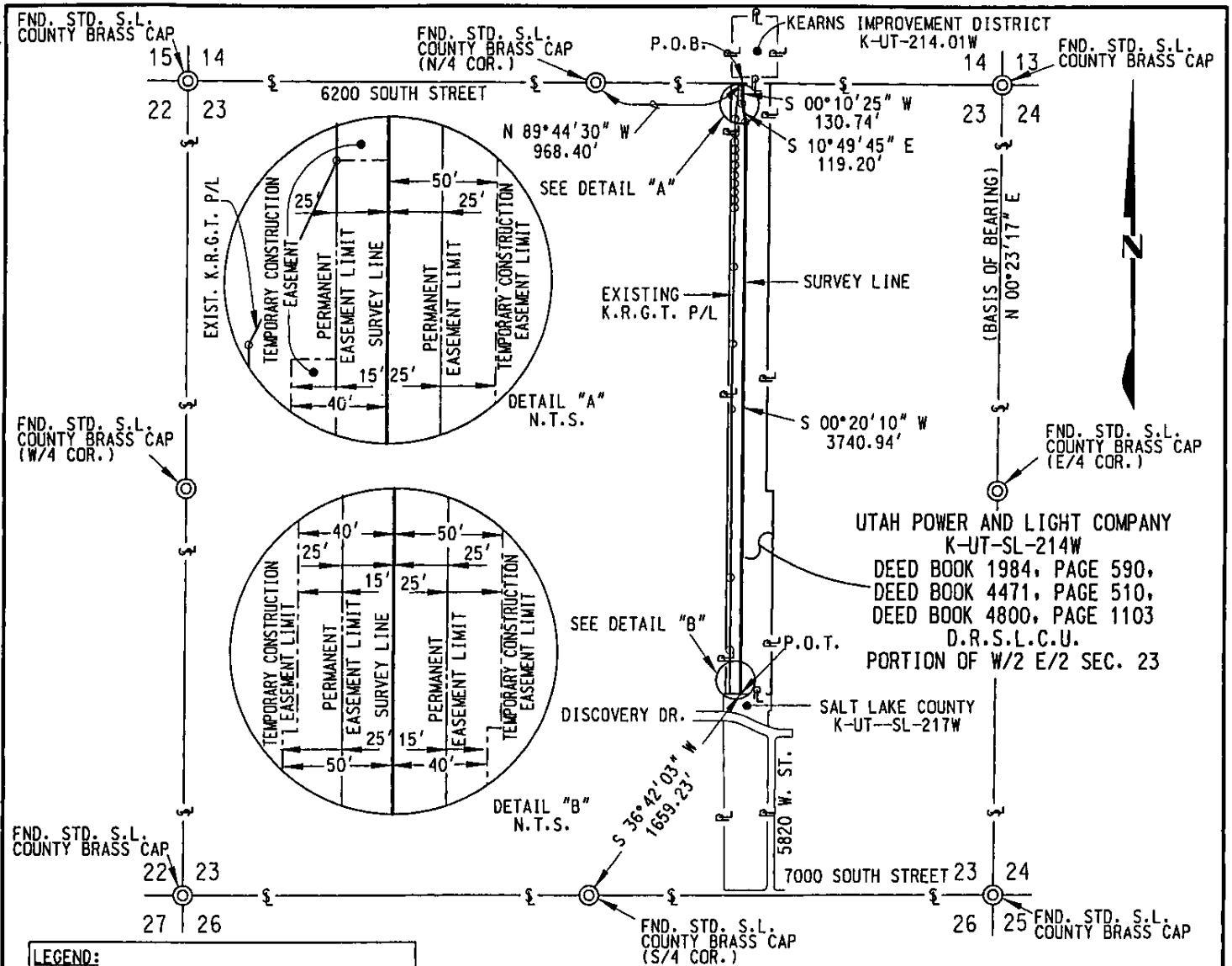

LEGEND:
 I.R. = IRON ROD
 P.O.B. = POINT OF BEGINNING
 P.O.T. = POINT OF TERMINUS
 FND. = FOUND
 K.R.G.T. = KERN RIVER GAS TRANSMISSION
 P/L = PIPELINE
 SPC = STATE COORDINATES SYSTEM
 NAD = NORTH AMERICAN DATUM
 D.R.S.L.C.U. = DEED RECORDS OF SALT LAKE COUNTY, UTAH



- NOTES:**
- BEARINGS AND DISTANCES ARE BASED ON THE "UTAH COORDINATE SYSTEM 1983 CENTRAL ZONE", DERIVED FROM GPS METHODS. SCALE FACTOR OF 0.999742630 APPLIED TO RODDAGE AND ACREAGE.
 - BASIS OF BEARING EAST LINE OF SECTION 23 BEING N 00°23'17" E
 - EASEMENT SURVEY AUGUST 2001.
 - PREPARED BY: UNIVERSAL ENSCO, INC. 1811 BERING DR. HOUSTON, TX. 77057

PROFESSIONAL LAND SURVEYOR
 I HEREBY CERTIFY THAT THIS PLAT IS A TRUE REPRESENTATION OF A SURVEY MADE BY ME OR UNDER MY DIRECT SUPERVISION
 MARY HENRY BREER, PLS #373234
 PROFESSIONAL LAND SURVEYOR

DRAWING NO.		REFERENCE TITLE		KERN RIVER GAS TRANSMISSION COMPANY PROPERTY PLAT PERMANENT, TEMPORARY CONST. & A.T.W.S. EASEMENTS CROSSING PROPERTY OF UTAH POWER AND LIGHT COMPANY T 2 S - R 2 W, SECTION 23 SALT LAKE COUNTY, UTAH						
NO.	DATE	BY	REVISION DESCRIPTION	W.O. NO.	CHK.	APP.	DRAWN BY: UEI	DATE: 04-02-2002	ISSUED FOR BID:	SCALE: 1" = 1000'
1	08-07-2002	UEI	REVISE EASEMENTS				CHECKED BY: UEI	DATE: 04-02-2002	ISSUED FOR CONSTRUCTION:	
							APPROVED BY:	DATE:	DRAWING NUMBER: K-UT-SL-214W	SHEET 1 OF 1

3K8661PG7677

EXHIBIT "N"

UTAH POWER AND LIGHT COMPANY
SALT LAKE COUNTY, UTAH
L.L. No. K-UT-SL-219W
SHEET 1 OF 1

A FIFTY (50) FOOT WIDE PERMANENT EASEMENT

Being a fifty (50) foot wide permanent easement lying twenty five (25) feet Westerly and twenty five (25) feet Easterly of the following described Survey line.

Said fifty (50) foot wide permanent easement extending over, through and across a portion of a certain tract conveyed to Utah Power and Light Company, and being located in a portion of the West Half of the Northeast Quarter of Section 26, Township 2 South, Range 2 West, Salt Lake Base and Meridian, Salt Lake County, Utah. Said tract being more particularly described in Deed Book 4471, Page 508 of the Deed Records of Salt Lake County, Utah, said Survey line being more particularly described as follows:

Beginning at a point on the North line of said tract, from which a Standard Salt Lake County Brass Cap found marking the North Quarter corner of said Section 26 bears North $88^{\circ}08'07''$ West, a distance of 984.15 feet;

THENCE South $00^{\circ}20'10''$ West, a distance of 2605.31 feet to a point of terminus on the South line of said tract, from which a Standard Salt Lake County Brass Cap found marking the East Quarter corner of said Section 26 bears North $89^{\circ}59'33''$ East, a distance of 1709.48 feet, said easement being 157.90 rods in length and contains 2.99 acres of land.

BK8661PG7678

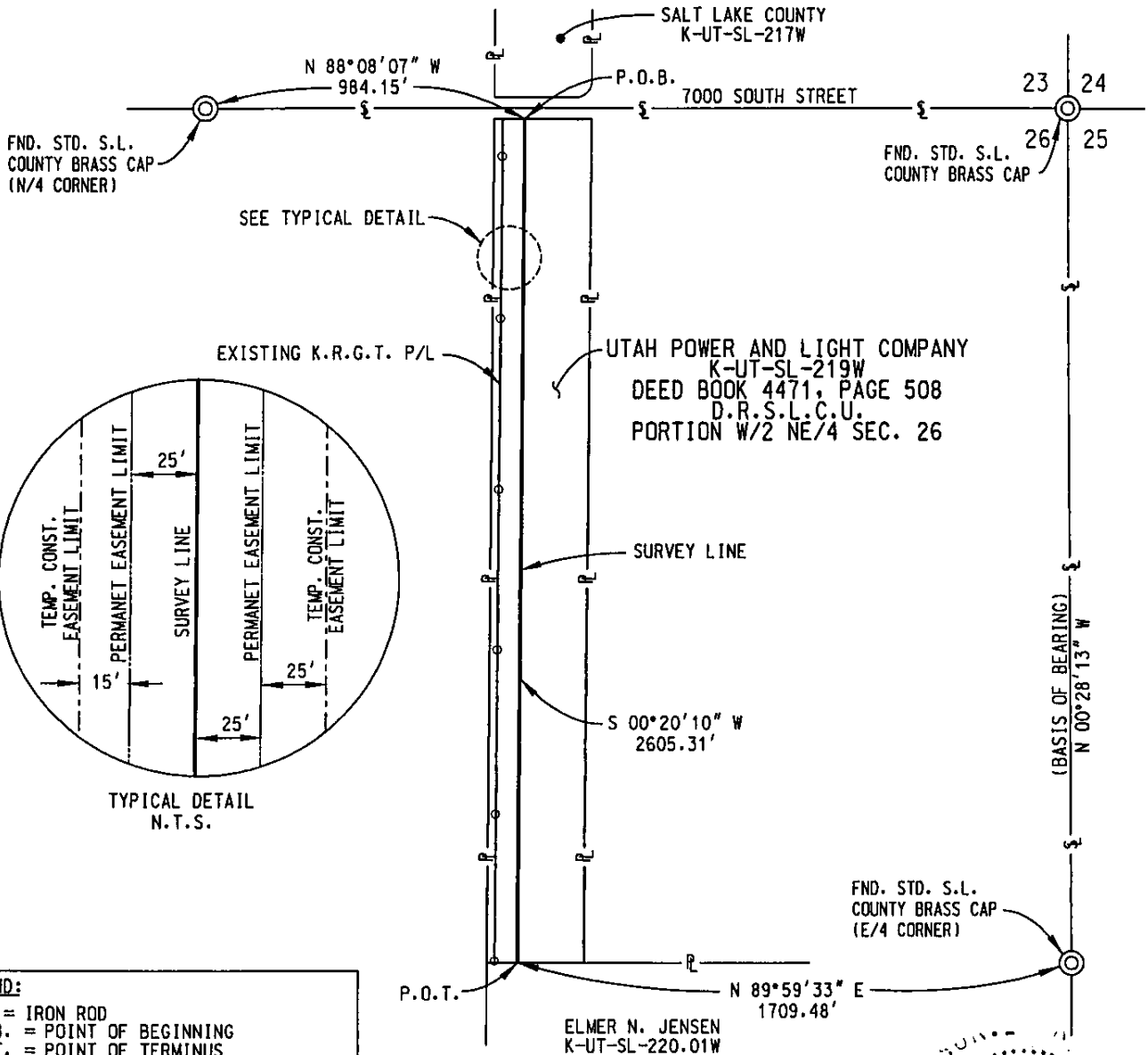

LEGEND:
 I.R. = IRON ROD
 P.O.B. = POINT OF BEGINNING
 P.O.T. = POINT OF TERMINUS
 FND. = FOUND
 K.R.G.T. = KERN RIVER GAS TRANSMISSION
 P/L = PIPELINE
 SPC = STATE COORDINATES SYSTEM
 NAD = NORTH AMERICAN DATUM
 D.R.S.L.C.U. = DEED RECORDS OF SALT LAKE COUNTY, UTAH

- NOTES:**
1. BEARINGS AND DISTANCES ARE BASED ON THE "UTAH COORDINATE SYSTEM 1983 CENTRAL ZONE", DERIVED FROM GPS METHODS. SCALE FACTOR OF 0.999742630 APPLIED TO RODDAGE AND ACREAGE.
 2. BASIS OF BEARING EAST LINE OF SECTION 26 BEING N 00°28'13" W
 3. EASEMENT SURVEY AUGUST 2001.
 4. PREPARED BY: UNIVERSAL ENSCO, INC. 1811 BERING DR. HOUSTON, TX. 77057

HEREBY CERTIFY THAT THIS PLAT IS A TRUE REPRESENTATION OF A SURVEY MADE BY ME OR UNDER MY DIRECT SUPERVISION.

GARY HENRY GREER PLS #373234
 PROFESSIONAL LAND SURVEYOR

DRAWING NO.		REFERENCE TITLE		KERN RIVER GAS TRANSMISSION COMPANY PROPERTY PLAT PERMANENT, TEMPORARY CONST. & A.T.W.S. EASEMENTS CROSSING PROPERTY OF UTAH POWER AND LIGHT COMPANY T 2 S - R 2 W, SECTION 26 SALT LAKE COUNTY, UTAH						
NO.	DATE	BY	REVISION DESCRIPTION	W.O. NO.	CHK.	APP.	DRAWN BY: UEI	DATE: 04-03-2002	ISSUED FOR BID:	SCALE: 1" = 500'
1	08-06-02	UEI	REVISE TEMPORARY CONSTRUCTION EASEMENTS AND A.T.W.S.				CHECKED BY: UEI	DATE: 04-03-2002	ISSUED FOR CONSTRUCTION:	
							APPROVED BY:	DATE:	DRAWING NUMBER: K-UT-SL-219W	SHEET 1 OF 1

EXHIBIT "O"

UTAH POWER AND LIGHT COMPANY
SALT LAKE COUNTY, UTAH
L.L. No. K-UT-SL-225W
SHEET 1 OF 1

A FIFTY (50) FOOT WIDE PERMANENT EASEMENT

Being a fifty (50) foot wide permanent easement lying twenty five (25) feet Westerly and twenty five (25) feet Easterly of the following described Survey line, also following an existing Kern River 36" pipeline.

Said fifty (50) foot wide permanent easement extending over, through and across a portion of a certain tract conveyed to Utah Power and Light Company, and being located in a portion of the Southeast Quarter of Section 35, Township 2 South, Range 2 West and in a portion of the Northeast Quarter of Section 2 Township 3 South, Range 2 West, Salt Lake Base and Meridian, Salt Lake County, Utah. Said tract being more particularly described in Deed Book 4810, Page 130 and Book 4471, Page 509 of the Deed Records of Salt Lake County, Utah, said Survey line being more particularly described as follows:

Beginning at a point on the North line of said tract, from which a Monument found marking the East Quarter corner of said Section 35 bears South 89°34'45" East, a distance of 1758.26 feet;

THENCE South 00°20'10" West, a distance of 2597.07 feet to a point on the South line of said Section 35 from which a Standard Salt Lake County Brass Cap found marking the South Quarter corner of said Section 35 bears North 89°23'06" West, a distance of 880.19 feet;

THENCE South 00°20'10" West, a distance of 827.38 feet to a point;

THENCE South 11°35'47" West, a distance of 40.01 feet to a point;

THENCE South 23°32'48" East, a distance of 40.01 feet to a point;

THENCE South 35°28'16" East, a distance of 312.17 feet to the point of terminus on the East line of said tract, from which a Standard Salt Lake County Brass Cap found marking the Northeast corner of said Section 2 bears North 54°02'50" East, a distance of 1939.06 feet; said easement being 231.31 rods in length and contains 4.38 acres of land.

BK 8661 PG 7680

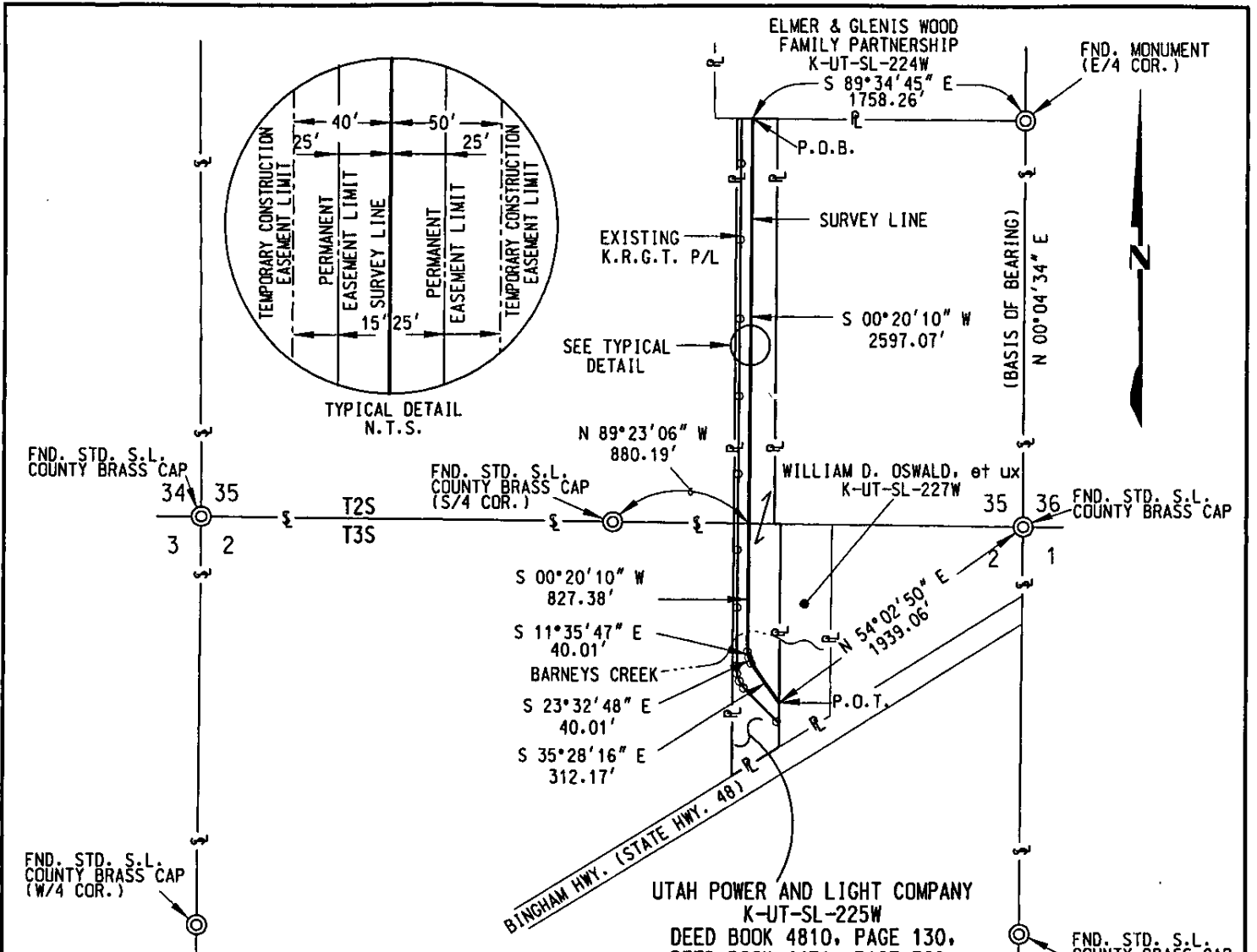

FND. STD. S.L. COUNTY BRASS CAP (S/4 COR.)

FND. STD. S.L. COUNTY BRASS CAP (S/4 COR.)

FND. STD. S.L. COUNTY BRASS CAP (E/4 COR.)

FND. STD. S.L. COUNTY BRASS CAP (W/4 COR.)

FND. STD. S.L. COUNTY BRASS CAP MARKED "1961" (E/4 COR.)

LEGEND:
 I.R. = IRON ROD
 P.O.B. = POINT OF BEGINNING
 P.O.T. = POINT OF TERMINUS
 FND. = FOUND
 K.R.G.T. = KERN RIVER GAS TRANSMISSION
 P/L = PIPELINE
 SPC = STATE COORDINATES SYSTEM
 NAD = NORTH AMERICAN DATUM
 D.R.S.L.C.U. = DEED RECORDS OF SALT LAKE COUNTY, UTAH

UTAH POWER AND LIGHT COMPANY
 K-UT-SL-225W
 DEED BOOK 4810, PAGE 130,
 DEED BOOK 4471, PAGE 509,
 D.R.S.L.C.U.
 PORTION OF SE/4 SEC. 35
 & PORTION OF NE/4 SEC. 2

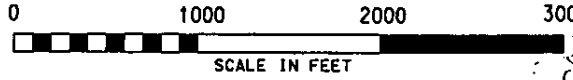

NOTES:

1. BEARINGS AND DISTANCES ARE BASED ON THE "UTAH COORDINATE SYSTEM 1983 CENTRAL ZONE", DERIVED FROM GPS METHODS. SCALE FACTOR OF 0.999742630 APPLIED TO RODDAGE AND ACREAGE.
2. BASIS OF BEARING EAST LINE OF SECTION 35 BEING N 00°04'34" E
3. EASEMENT SURVEY AUGUST 2001.
4. PREPARED BY: UNIVERSAL ENSCO, INC. 1811 BERING DR. HOUSTON, TX. 77057

3000 SURVEYOR
 I HEREBY CERTIFY THAT THIS PLAT IS A TRUE REPRESENTATION OF A SURVEY MADE BY ME OR UNDER MY DIRECT SUPERVISION.
 Gary Henry Greer
 GARY HENRY GREER PLS #373234
 PROFESSIONAL LAND SURVEYOR

DRAWING NO.		REFERENCE TITLE		KERN RIVER GAS TRANSMISSION COMPANY PROPERTY PLAT PERMANENT, TEMPORARY CONST. & A.T.W.S. EASEMENTS CROSSING PROPERTY OF UTAH POWER AND LIGHT COMPANY T 2 S - R 2 W, SEC. 35 & T 3 S - R 2 W, SEC. 2 SALT LAKE COUNTY, UTAH						
NO.	DATE	BY	REVISION DESCRIPTION	W.O. NO.	CHK.	APP.	DRAWN BY: UEI	DATE: 04-03-2002	ISSUED FOR BID:	SCALE: 1" = 1000'
1	8-08-2002	UEI	REVISE EASEMENTS				CHECKED BY: UEI	DATE: 04-03-2002	ISSUED FOR CONSTRUCTION:	
							APPROVED BY:	DATE:	DRAWING NUMBER: K-UT-SL-225W	SHEET 1 OF 1

BK 8661 PG 7681

EXHIBIT "P"

UTAH POWER AND LIGHT COMPANY
SALT LAKE COUNTY, UTAH
L.L. No. K-UT-SL-233-239W
SHEET 1 OF 2

PERMANENT EASEMENT

Being a twenty five (25) foot wide permanent easement lying twenty five (25) feet Easterly of the following described Survey line to a point of convergence whereas the herein described easement changes to a fifty (50) foot wide permanent easement lying twenty five (25) feet Westerly and twenty five (25) feet Easterly of the following described Survey line, also following an existing Kern River 36" pipeline.

Said twenty five (25) foot and fifty (50) foot wide permanent easements extending over, through and across a portion of a certain tract conveyed to Utah Power and Light Company, and being located in a portion of the Southeast Quarter of Section 2, a portion of the East Half of Section 11, and a portion of the Northeast corner of section 14, Township 3 South, Range 2 West, Salt Lake Base and Meridian, Salt Lake County, Utah. Said tract being more particularly described in Deed Book 4808, Page 1280, Deed Book 3801, Page 209, Deed Book 4472, Page 753, Deed Book 2073, Page 334, and Deed Book 4362, Page 429 of the Deed Records of Salt Lake County, Utah, said Survey line being more particularly described as follows:

Beginning at a point on the East line of said tract, from which a Standard Salt Lake County Brass Cap found marking the East Quarter corner of said Section 2 bears North 79°39'50" East, a distance of 1641.27 feet;

THENCE South 51°10'01" West, a distance of 118.20 feet to a point of convergence whereas said twenty five (25) foot wide permanent easement ends and said fifty (50) foot wide permanent easement begins of the herein continued description of said Survey line;

THENCE South 40°59'45" West, a distance of 40.01 feet to a point;

THENCE South 30°50'27" West, a distance of 40.02 feet to a point;

THENCE South 20°40'24" West, a distance of 40.01 feet to a point;

THENCE South 10°30'03" West, a distance of 40.01 feet to a point;

THENCE South 00°20'36" West, a distance of 2114.23 feet to a point on the South line of said Section 2 from which a Standard Salt Lake County Brass Cap found marking the Southeast corner bears South 89°32'24" East, a distance of 1773.10 feet;

BK 8661 PG 7682

UTAH POWER AND LIGHT COMPANY (Continued)
SALT LAKE COUNTY, UTAH
L.L. No. K-UT-SL-233-239W
SHEET 2 OF 2

THENCE South 00°20'36" West, a distance of 4107.64 feet to a point;

THENCE South 45°30'23" West, a distance of 149.54 feet to a point of exit on the West property line of said tract;

THENCE South 45°30'23" West, a distance of 105.71 feet across lands of others to a point;

THENCE South 00°30'09" West, a distance of 1075.93 feet across lands of others to a point of entry on the Southern most North line of said property, from which a Standard Salt Lake County Brass Cap found marking the South Quarter corner of said Section 11 bears North 89°35'48" West, a distance of 789.44 feet;

THENCE South 00°30'09" West, a distance of 33.64 feet to a point;

THENCE South 00°33'23" East, a distance of 906.49 feet to a point of terminus on the South line of said tract, from which a Standard Salt Lake County Brass Cap found marking the Northeast corner of said Section 14 bears North 63°25'34" East, a distance of 2072.14 feet, said easement being 459.99 rods in length and contains 8.64 acres of land.

BK 866 | PG 7683

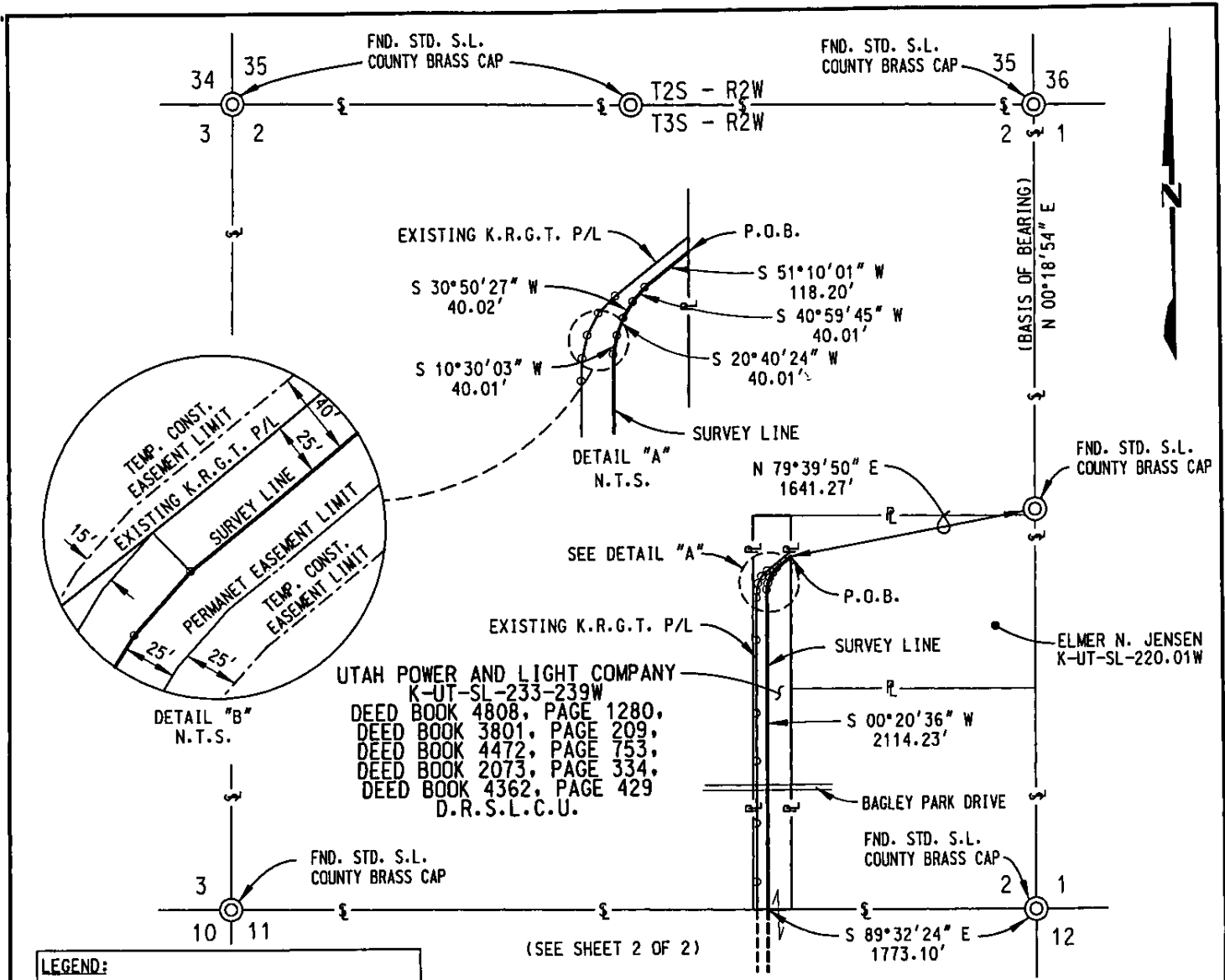

LEGEND:
 I.R. = IRON ROD
 P.O.B. = POINT OF BEGINNING
 P.O.T. = POINT OF TERMINUS
 FND. = FOUND
 K.R.G.T. = KERN RIVER GAS TRANSMISSION
 P/L = PIPELINE
 SPC = STATE COORDINATES SYSTEM
 NAD = NORTH AMERICAN DATUM
 D.R.S.L.C.U. = DEED RECORDS OF SALT LAKE COUNTY, UTAH



- NOTES:**
- BEARINGS AND DISTANCES ARE BASED ON THE "UTAH COORDINATE SYSTEM 1983 CENTRAL ZONE", DERIVED FROM GPS METHODS. SCALE FACTOR OF 0.999742630 APPLIED TO RODDAGE AND ACREAGE.
 - BASIS OF BEARING EAST LINE OF SECTION 2 BEING N 00°18'54" E
 - EASEMENT SURVEY AUGUST 2001.
 - PREPARED BY: UNIVERSAL ENSCO, INC. 1811 BERING DR. HOUSTON, TX. 77057

SURVEYOR
 I HEREBY CERTIFY THAT THIS PLAT IS A TRUE REPRESENTATION OF A SURVEY MADE BY ME OR UNDER MY DIRECT SUPERVISION.
 GARY HENRY GREER PLS #373234
 PROFESSIONAL LAND SURVEYOR

DRAWING NO.		REFERENCE TITLE		KERN RIVER GAS TRANSMISSION COMPANY PROPERTY PLAT PERMANENT, TEMPORARY CONST. & A.T.W.S. EASEMENTS CROSSING PROPERTY OF UTAH POWER AND LIGHT COMPANY T 3 S - R 2 W, SECTIONS 2, 11, & 14 SALT LAKE COUNTY, UTAH						
NO.	DATE	BY	REVISION DESCRIPTION	W.O. NO.	CHK.	APP.	DRAWN BY: UEI	DATE: 04-03-2002	ISSUED FOR BID:	SCALE: 1" = 1000'
01	08-12-02	UEI	REVISED TEMPORARY CONSTRUCTION & A.T.W.S. EASEMENTS				CHECKED BY: UEI	DATE: 04-03-2002	ISSUED FOR CONSTRUCTION:	
							APPROVED BY:	DATE:	DRAWING NUMBER: K-UT-SL-233-239W	SHEET 1 OF 2

BK8661PG7684

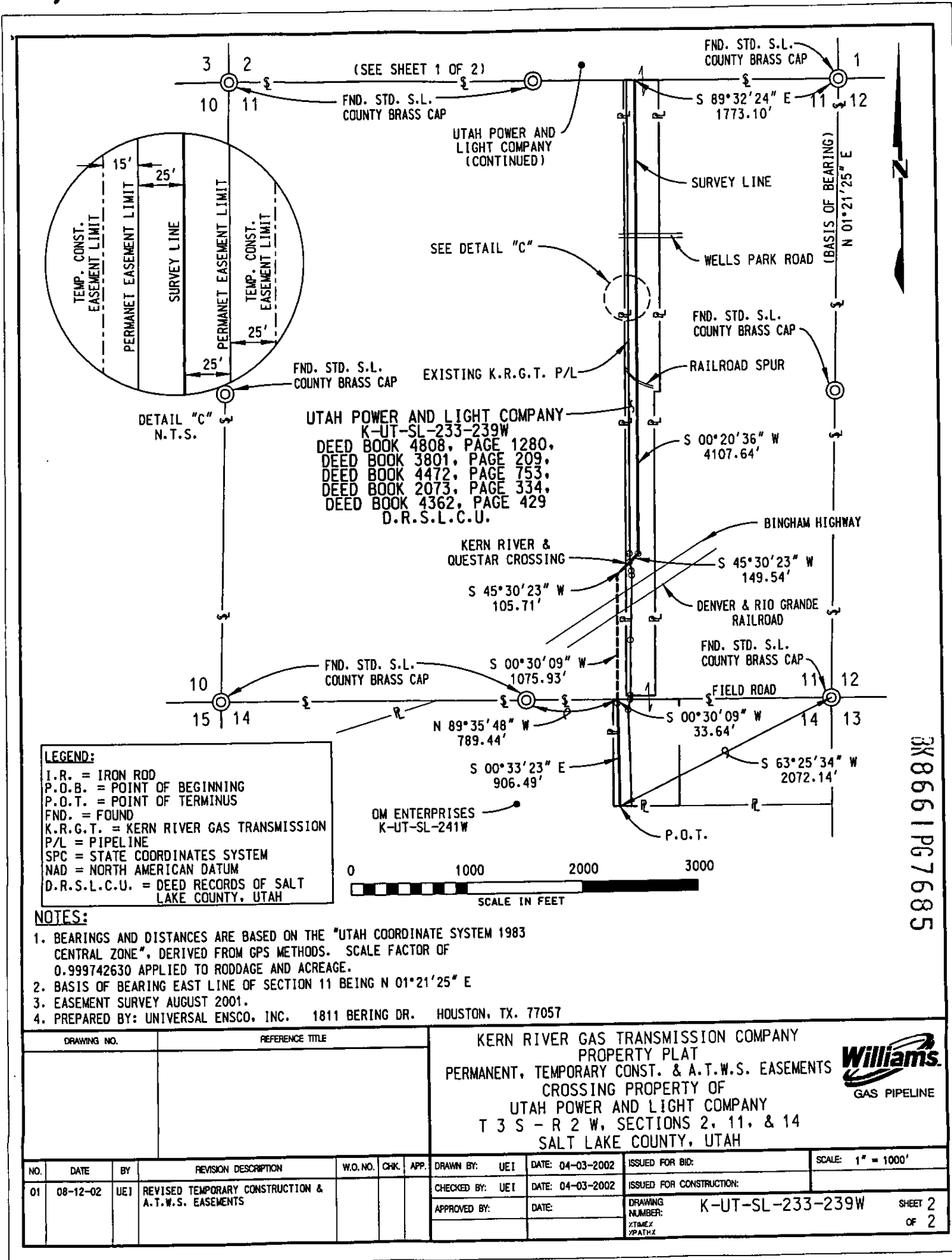

DRAWING NO.		REFERENCE TITLE		KERN RIVER GAS TRANSMISSION COMPANY PROPERTY PLAT PERMANENT, TEMPORARY CONST. & A.T.W.S. EASEMENTS CROSSING PROPERTY OF UTAH POWER AND LIGHT COMPANY T 3 S - R 2 W, SECTIONS 2, 11, & 14 SALT LAKE COUNTY, UTAH						
NO.	DATE	BY	REVISION DESCRIPTION	W.O.NO.	CHK.	APP.	DRAWN BY: UEI	DATE: 04-03-2002	ISSUED FOR BID:	SCALE: 1" = 1000'
01	08-12-02	UEI	REVISED TEMPORARY CONSTRUCTION & A.T.W.S. EASEMENTS				CHECKED BY: UEI	DATE: 04-03-2002	ISSUED FOR CONSTRUCTION:	
							APPROVED BY:	DATE:	DRAWING NUMBER: K-UT-SL-233-239W	SHEET 2 OF 2

EXHIBIT "Q"

UTAH POWER AND LIGHT COMPANY
SALT LAKE COUNTY, UTAH
L.L. No. K-UT-SL-242W
SHEET 1 OF 1

A PERMANENT EASEMENT

Being a permanent easement five (5) feet wide more or less extending Westerly from the following described Survey line to the Westerly line of herein described tract, also following an existing Kern River 36" pipeline.

Said permanent easement extending over, through and across a portion of a certain tract conveyed to Utah Power and Light Company, and being located in a portion of the South Half of the Southeast Quarter of Section 14, Township 3 South, Range 2 West, Salt Lake Base and Meridian, Salt Lake County, Utah. Said tract being more particularly described in Deed Book 2071, Page 357 and Deed Book 5315, Page 486 of the Deed Records of Salt Lake County, Utah, said Survey line being more particularly described as follows:

Beginning at a point on the North line of said tract, from which a standard Salt Lake County Brass Cap marked "1961" found marking the South Quarter corner of said Section 14 bears South 33°53'53" West, a distance of 1586.75 feet;

THENCE South 00°20'28" West, a distance of 405.37 feet to a point;

THENCE South 09°01'02" East, a distance of 40.01 feet to a point;

THENCE South 18°21'45" East, a distance of 40.01 feet to a point;

THENCE South 27°42'43" East, a distance of 40.01 feet to a point;

THENCE South 37°03'35" East, a distance of 1011.15 feet to the point of terminus on the South line of said Section 14, from which a standard Salt Lake County Brass Cap marked "1961" found marking the Southeast corner of said Section 14 bears South 89°41'44" East, a distance of 1118.39 feet, said easement being 93.12 rods in length and contains 0.21 acres of land.

BK8661 PG7686

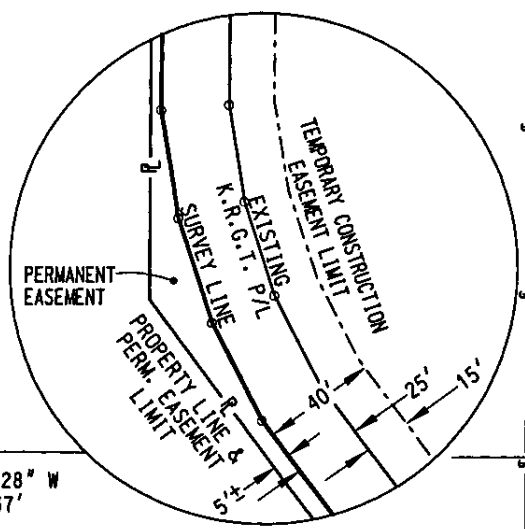

TYPICAL DETAIL
N.T.S.

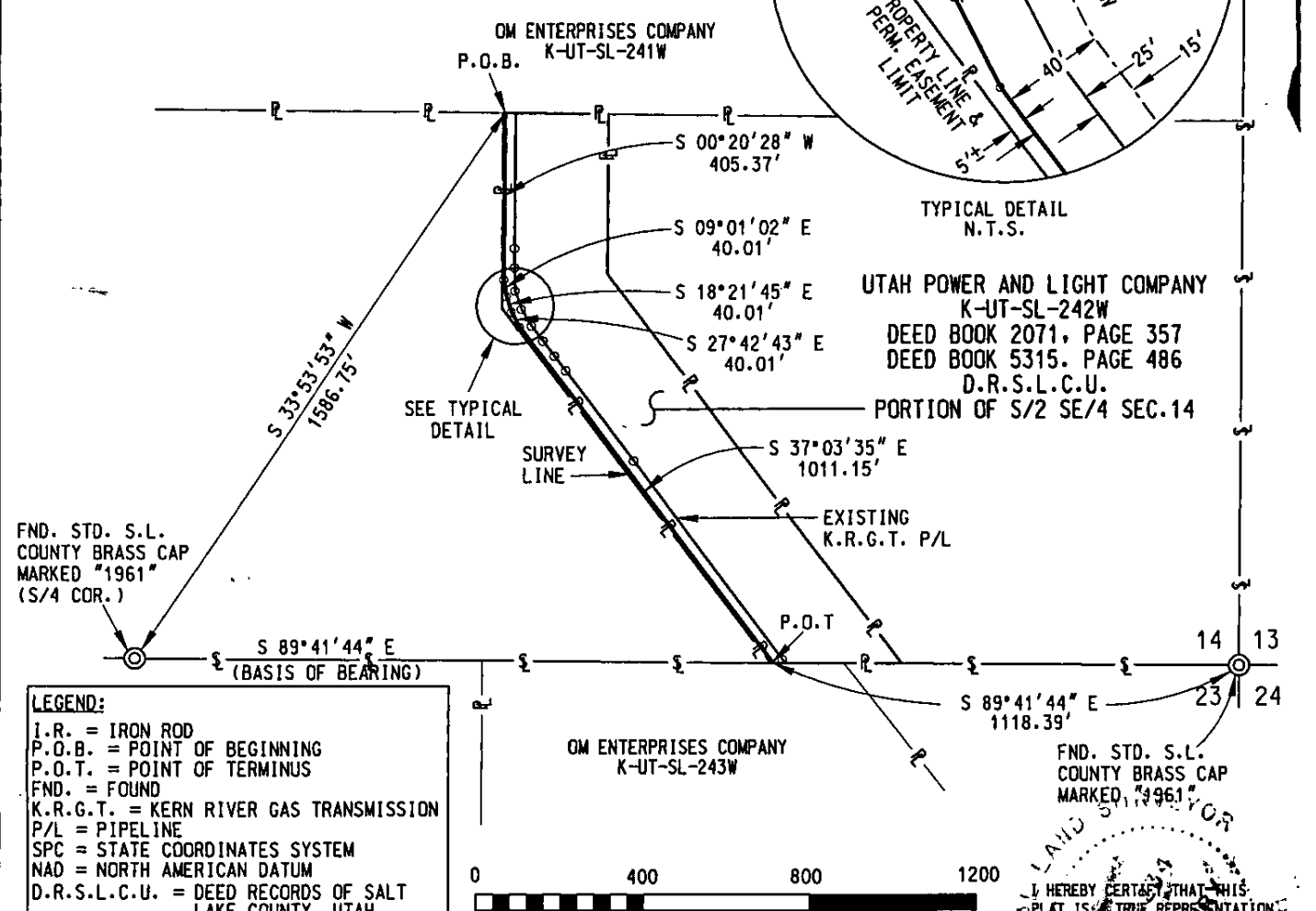

LEGEND:
 I.R. = IRON ROD
 P.O.B. = POINT OF BEGINNING
 P.O.T. = POINT OF TERMINUS
 FND. = FOUND
 K.R.G.T. = KERN RIVER GAS TRANSMISSION
 P/L = PIPELINE
 SPC = STATE COORDINATES SYSTEM
 NAD = NORTH AMERICAN DATUM
 D.R.S.L.C.U. = DEED RECORDS OF SALT LAKE COUNTY, UTAH

- NOTES:**
1. BEARINGS AND DISTANCES ARE BASED ON THE "UTAH COORDINATE SYSTEM 1983 CENTRAL ZONE", DERIVED FROM GPS METHODS. SCALE FACTOR OF 0.999742630 APPLIED TO RODDAGE AND ACREAGE.
 2. BASIS OF BEARING SOUTH LINE OF SECTION 14 BEING S 89°41'44" E
 3. EASEMENT SURVEY AUGUST 2001.
 4. PREPARED BY: UNIVERSAL ENSCO, INC. 1811 BERING DR. HOUSTON, TX. 77057

I HEREBY CERTIFY THAT THIS PLAT IS A TRUE REPRESENTATION OF A SURVEY MADE BY ME OR UNDER MY DIRECT SUPERVISION.

Gary Henry Greer
 GARY HENRY GREER PLS #573234
 PROFESSIONAL LAND SURVEYOR

DRAWING NO.		REFERENCE TITLE		KERN RIVER GAS TRANSMISSION COMPANY PROPERTY PLAT PERMANENT AND TEMPORARY CONSTRUCTION EASEMENTS CROSSING PROPERTY OF UTAH POWER AND LIGHT COMPANY T 3 S - R 2 W, SECTION 14 SALT LAKE COUNTY, UTAH						
NO.	DATE	BY	REVISION DESCRIPTION	W.O.NO.	CHK.	APP.	DRAWN BY: UEI	DATE: 04-08-2002	ISSUED FOR BID:	SCALE: 1" = 400'
							CHECKED BY: UEI	DATE: 04-08-2002	ISSUED FOR CONSTRUCTION:	
							APPROVED BY:	DATE:	DRAWING NUMBER: K-UT-SL-242W	SHEET 1 OF 1

BK8661PG7687

EXHIBIT "R"

UTAH POWER AND LIGHT COMPANY
SALT LAKE COUNTY, UTAH
L.L. No. K-UT-SL-278-280W
SHEET 1 OF 1

A FIFTY (50) FOOT WIDE PERMANENT EASEMENT

Being a fifty (50) foot wide permanent easement lying twenty five (25) feet Northeasterly and twenty five (25) feet Southwesterly of the following described Survey line, also following an existing Kern River 36" pipeline.

Said fifty (50) foot wide permanent easement extending over, through and across a portion of a certain tract conveyed to Utah Power and Light Company, and being located in a portion of the West Half of Section 9, Township 4 South, Range 1 West, Salt Lake Base and Meridian, Salt Lake County, Utah. Said tract being more particularly described in Deed Book 2010, Page 340, Deed Book 2013, Page 444, Deed Book 2014, Page 113, Deed Book 2088, Page 224, Deed Book 3981, Page 168, Deed Book 5015, Page 430 and Deed Book 5410, Page 2569 of the Deed Records of Salt Lake County, Utah, said Survey line being more particularly described as follows:

Beginning at a point on the North line of said tract, from which a Standard Salt Lake County Brass Cap marked "1915" found marking the Northwest corner of said Section 9 bears North $06^{\circ}58'52''$ West, a distance of 1015.12 feet;

THENCE South $37^{\circ}04'23''$ East, a distance of 366.20 feet to a point on the North line of lands of others;

THENCE South $37^{\circ}04'23''$ East, a distance of 62.92 feet across lands of others to a point on the South line of lands of others;

THENCE South $37^{\circ}04'23''$ East, a distance of 1311.49 feet to a point;

THENCE South $31^{\circ}37'02''$ East, a distance of 3561.02 feet to a point of terminus on the South line of said tract, from which a Standard Salt Lake County Brass Cap marked "1993" found marking the South Quarter corner of said Section 9 bears South $84^{\circ}58'26''$ West, a distance of 353.34 feet; Said easement being 306.59 rods in length and contains 5.81 acres of land.

BK8661PG7688

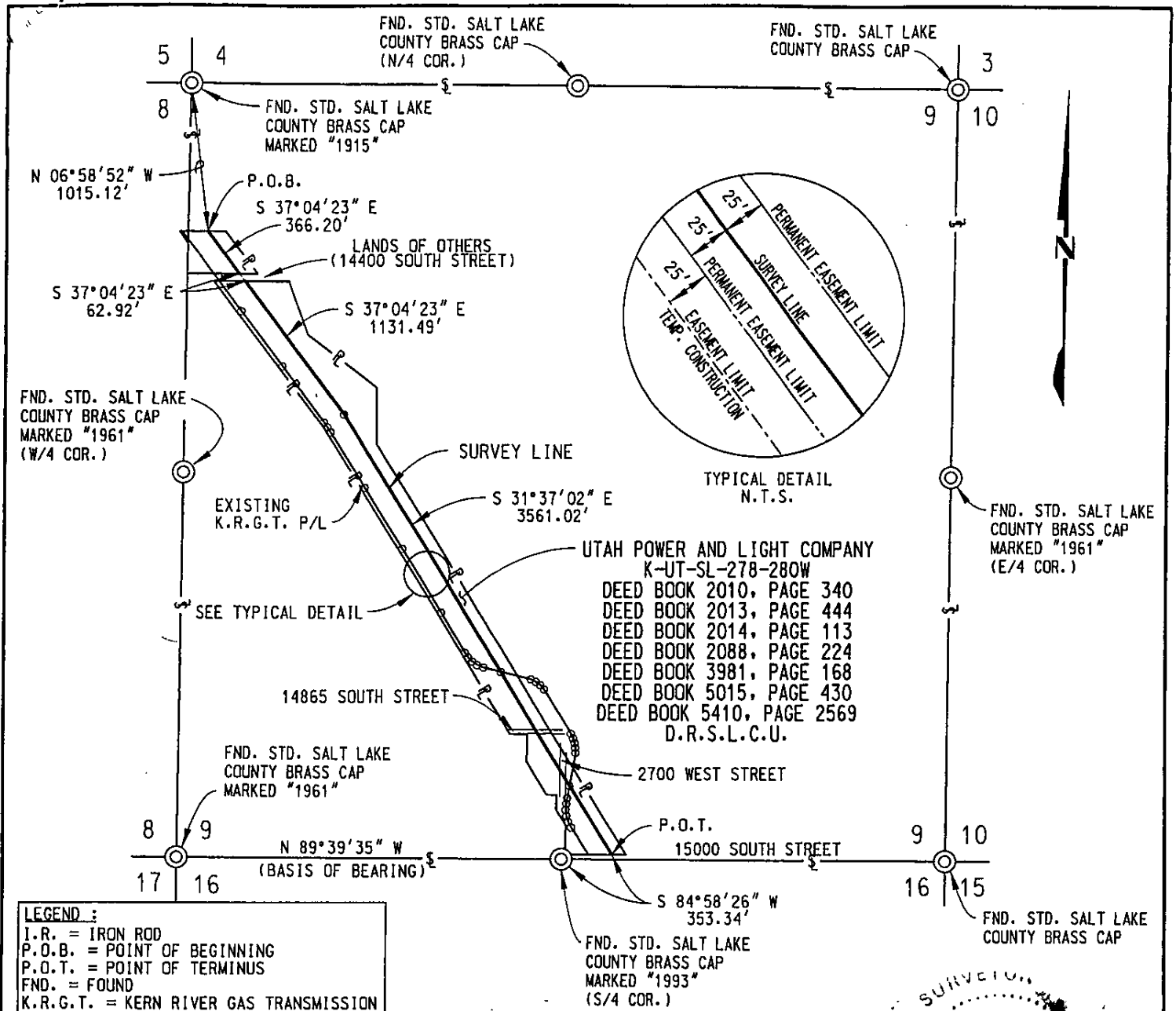

UTAH POWER AND LIGHT COMPANY
 K-UT-SL-278-280W
 DEED BOOK 2010, PAGE 340
 DEED BOOK 2013, PAGE 444
 DEED BOOK 2014, PAGE 113
 DEED BOOK 2088, PAGE 224
 DEED BOOK 3981, PAGE 168
 DEED BOOK 5015, PAGE 430
 DEED BOOK 5410, PAGE 2569
 D.R.S.L.C.U.

LEGEND :
 I.R. = IRON ROD
 P.O.B. = POINT OF BEGINNING
 P.O.T. = POINT OF TERMINUS
 FND. = FOUND
 K.R.G.T. = KERN RIVER GAS TRANSMISSION
 P/L = PIPELINE
 SPC = STATE COORDINATES SYSTEM
 NAD = NORTH AMERICAN DATUM
 D.R.S.L.C.U. = DEED RECORDS OF SALT LAKE COUNTY, UTAH



- NOTES:**
1. BEARINGS AND DISTANCES ARE BASED ON THE "UTAH COORDINATE SYSTEM 1983 CENTRAL ZONE", DERIVED FROM GPS METHODS. SCALE FACTOR OF 0.999742630 APPLIED TO RODDAGE AND ACREAGE.
 2. BASIS OF BEARING SOUTH LINE OF SECTION 9 BEING N 89° 39' 35" W
 3. EASEMENT SURVEY AUGUST 2001.
 4. PREPARED BY: UNIVERSAL ENSCO, INC. 1811 BERING DR. HOUSTON, TX. 77057

I HEREBY CERTIFY THAT THIS PLAT IS A TRUE REPRESENTATION OF A SURVEY MADE BY ME OR UNDER MY DIRECT SUPERVISION.

Gary Henry Greer
 GARY HENRY GREER PLS #373234
 PROFESSIONAL LAND SURVEYOR

DRAWING NO.		REFERENCE TITLE		KERN RIVER GAS TRANSMISSION COMPANY PROPERTY PLAT PERMANENT, TEMPORARY CONST. & A.T.W.S. EASEMENTS CROSSING PROPERTY OF UTAH POWER AND LIGHT COMPANY T 4 S - R 1 W, SECTION 9 SALT LAKE COUNTY, UTAH						
NO.	DATE	BY	REVISION DESCRIPTION	W.O. NO.	CHK.	APP.	DRAWN BY: UE1	DATE: 04-11-2002	ISSUED FOR BID:	SCALE: 1" = 1000'
1	8-22-2002	UE1	REVISE EASEMENTS				CHECKED BY: UE1	DATE: 04-11-2002	ISSUED FOR CONSTRUCTION:	
							APPROVED BY:	DATE:	DRAWING NUMBER: K-UT-SL-278-280W	SHEET 1 OF 1

BK8661PG7689

EXHIBIT "S"

UTAH POWER AND LIGHT COMPANY
SALT LAKE COUNTY, UTAH
L.L. No. K-UT-SL-283W
SHEET 1 OF 1

A FIFTY (50) FOOT WIDE PERMANENT EASEMENT

Being a fifty (50) foot wide permanent easement lying twenty five (25) feet Northeasterly and twenty five (25) feet Southwesterly of the following described Survey line.

Said fifty (50) foot wide permanent easement extending over, through and across a portion of a certain tract conveyed to Utah Power and Light Company, and being located in a portion of the Northeast Quarter of Section 16, Township 4 South, Range 1 West, Salt Lake Base and Meridian, Salt Lake County, Utah. Said tract being more particularly described in Deed Book 2073, Page 36, Deed Book 2073, Page 336, and Deed Book 5122, Page 342 of the Deed Records of Salt Lake County, Utah, said Survey line being more particularly described as follows:

Beginning at a point on the North line of said tract, from which a Standard Salt Lake County Brass Cap marked "1993" found marking the North Quarter corner of said Section 16 bears North 85°58'50" West, a distance of 388.77 feet;

THENCE South 31°37'02" East, a distance of 1414.57 feet to a point;

THENCE South 21°44'54" East, a distance of 40.01 feet to a point;

THENCE South 11°52'44" East, a distance of 107.22 feet to a point of terminus on a Southerly line of said tract, from which a Standard Salt Lake County Brass Cap found marking the Northeast corner of said Section 16 bears North 47°21'52" East, a distance of 2005.81 feet; said easement being 94.65 rods in length and contains 1.79 acres of land.

BK8661PG7690

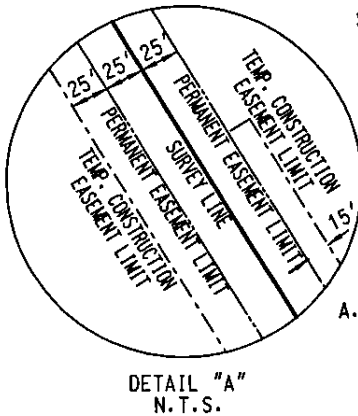
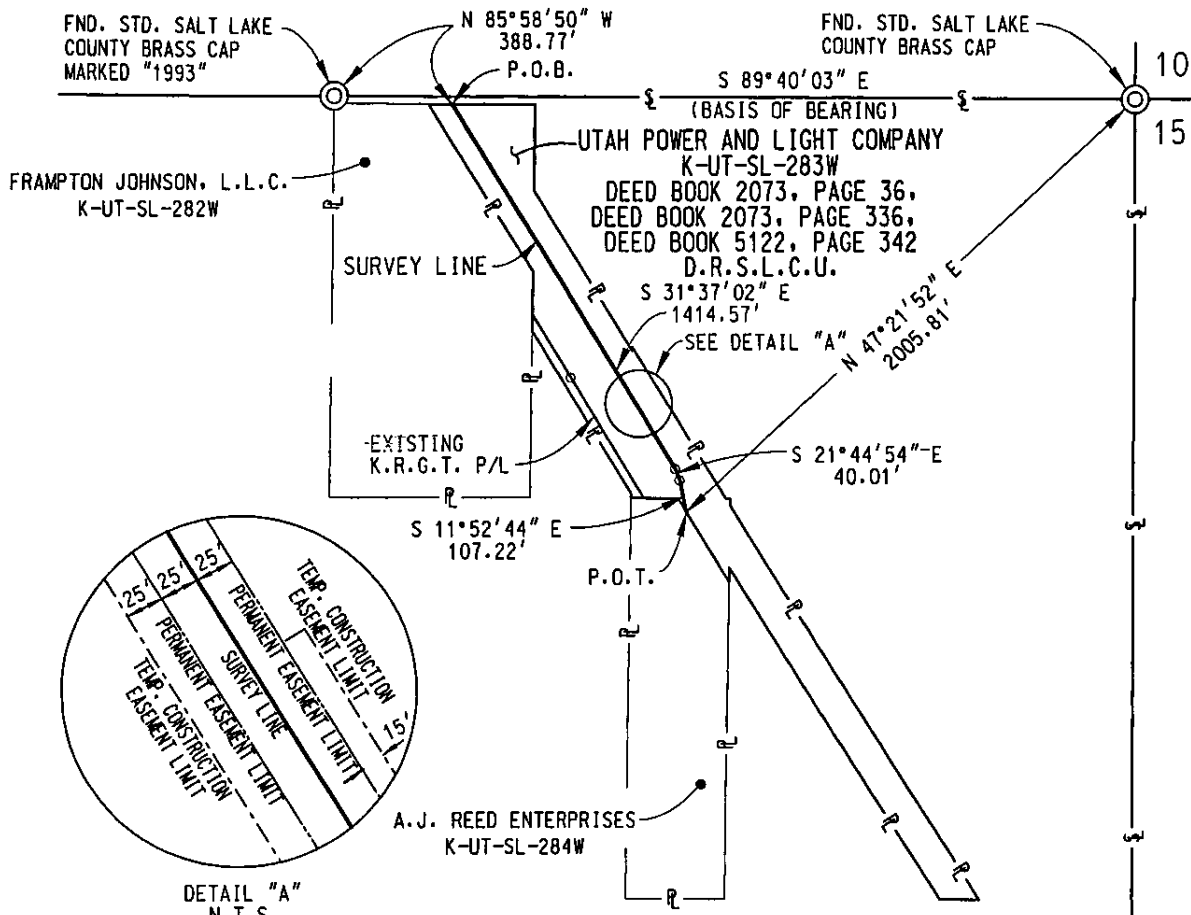

LEGEND :
 I.R. = IRON ROD
 P.O.B. = POINT OF BEGINNING
 P.O.T. = POINT OF TERMINUS
 FND. = FOUND
 K.R.G.T. = KERN RIVER GAS TRANSMISSION
 P/L = PIPELINE
 SPC = STATE COORDINATES SYSTEM
 NAD = NORTH AMERICAN DATUM
 D.R.U.C.U. = DEED RECORDS OF UTAH COUNTY, UTAH

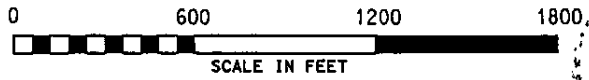

- NOTES:**
1. BEARINGS AND DISTANCES ARE BASED ON THE "UTAH COORDINATE SYSTEM 1983 CENTRAL ZONE", DERIVED FROM GPS METHODS. SCALE FACTOR OF 0.999742630 APPLIED TO RODDAGE AND ACREAGE.
 2. BASIS OF BEARING EAST LINE OF SECTION 16 BEING S 89°40'03" E
 3. EASEMENT SURVEY SEPTEMBER 2001.
 4. PREPARED BY: UNIVERSAL ENSCO, INC. 1811 BERING DR. HOUSTON, TX. 77057

LAND SURVEYOR
 I HEREBY CERTIFY THAT THIS PLAT IS A TRUE REPRESENTATION OF A SURVEY MADE BY ME OR UNDER MY DIRECT SUPERVISION
 GARY HENRY BRIDGES PLS. #373234
 PROFESSIONAL LAND SURVEYOR

DRAWING NO.		REFERENCE TITLE		KERN RIVER GAS TRANSMISSION COMPANY PROPERTY PLAT PERMANENT, TEMPORARY CONST. & A.T.W.S. EASEMENTS CROSSING PROPERTY OF UTAH POWER AND LIGHT COMPANY T 4 S - R 1 W, SECTION 16 SALT LAKE COUNTY, UTAH						
NO.	DATE	BY	REVISION DESCRIPTION	W.O. NO.	CHK.	APP.	DRAWN BY: UEI	DATE: 04-11-2002	ISSUED FOR BID:	SCALE: 1" = 600'
1	8-08-2002	UEI	REVISE EASEMENTS				CHECKED BY: UEI	DATE: 04-11-2002	ISSUED FOR CONSTRUCTION:	
							APPROVED BY:	DATE:	DRAWING NUMBER: K-UT-SL-283W	SHEET 1 OF 1

BK8661PG7691