

KENNECOTT MASTER SUBDIVISION #1

SURVEYOR'S CERTIFICATION & BOUNDARY DESCRIPTION

I, James M. Bagwell, do hereby certify that I am a Professional Land Surveyor and that I hold Certificate No. 358275 as prescribed by The State of Utah. I further certify that I have directed a survey of the tracts of land shown hereon, and that the corners have been established and marked as indicated. No easements of record have been depicted hereon.

James M. Bagwell
James M. Bagwell, P.L.S. #358275

05-27-02
Date:

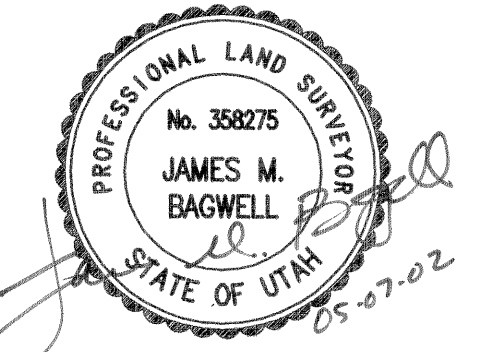

A tract of land situated in Sections 18 and 19, Township 3 South, Range 1 West and Sections 13, 14, 15, 22, 23 and 24, Township 3 South, Range 2 West, Salt Lake Base and Meridian, said tract being more particularly described as follows:

BEGINNING at a Salt Lake County monument marking the Northwest corner of said Section 13; thence North 89°57'24" East along the north line of said section for 2699.959 feet to a Salt Lake County monument marking the North quarter corner of said Section 13; thence continuing along said north line North 89°57'36" East for 2666.551 feet to a point marking the northwest corner of a parcel described in that certain Quit Claim Deed recorded in Book 6833 at Page 52, from which a Salt Lake County monument marking the Northeast corner of said Section 13 bears North 89°57'36" East - 33.000 feet; thence along the west and south lines of said parcel the following two (2) calls: (1) South 00°15'56" West for 33.000 feet; (2) thence North 89°57'36" East intersecting the east line of said Section 13 at 33.000 feet and continuing on along the south line of said parcel for a total of 33.178 feet; thence North 89°57'12" East parallel to and 33.000 feet perpendicular south of the north line of Section 18, Township 3 South, Range 1 West and along the said south right of way of 10200 South and 2574.761 feet to an angle point; thence continuing parallel with said north line and along the said south right of way North 89°58'34" East for 278.761 feet to a point of intersection with the south right of way of 10200 South and an extension of the west line of the property conveyed to Oquirrh Shadows, L.C. as recorded in Book 8221 at Page 869; thence South 23°56'44" East passing the northwest corner of said property at 0.591 feet and continuing along the west line of said property for a total of 634.361 feet to an angle point; thence continuing along said west line South 29°39'04" East for 1012.874 feet to the northeast corner of a parcel conveyed to South Jordan City, recorded in Book 8401 at Page 5930; thence along the perimeter of said South Jordan City property the following four (4) calls: (1) South 60°20'55" West for 360.045 feet; (2) thence South 29°39'05" East for 496.250 feet; (3) thence North 33°11'06" East for 98.140 feet; (4) thence with a curve to the right, having a radius of 1653.000 feet, a central angle of 10°12'46" (chord bearing and distance of North 38°17'57" East - 294.249 feet) and for an arc distance of 294.639 feet, said point being the southeast corner of South Jordan City and lying on the north right of way of 10400 South Street, said point also lying on the west line of said Oquirrh Shadows property, thence South 29°39'04" East along said west line for 2916.402 feet to the south east corner of said Oquirrh Shadows property, said point also lying on the east line of said Section 18; thence South 00°07'15" East along said east line for 967.184 feet to a Salt Lake County monument marking the northeast corner of Section 19; thence South 00°07'47" East along the East line of said Section 19 for 1326.083 feet to the northeast corner of the William B. Wray Jr. parcel, also known as Parcel 3 in Commitment for Title Insurance, Amendment No. 3, Order No. 00113350; thence along the north and west lines of said parcel 3 the following two (2) calls: (1) South 89°58'28" West for 1316.070 feet; (2) thence South 00°04'54" East for 1324.371 feet to a point on the North line of Country Crossing Subdivision No. 5, recorded as Entry No. 7422489 in Plat Book 99-7P at Page 204; thence along the north and west lines of said subdivision, phase No. 5, 4 and 3 the following two (2) calls: (1) North 89°56'46" West for 1320.153 feet; (2) thence South 00°01'42" West for 2609.121 feet to the southwest corner of said Country Crossing Subdivision No. 3, said point also lying on the north right of way of 11800 South Street; thence along said north right of way line the following three (3) calls: (1) North 89°52'04" West for 2642.116 feet; (2) thence North 89°58'42" West for 2677.945 feet; (3) thence North 89°58'44" West for 2677.394 feet to a point of intersection of the north right of way line of said 11800 South Street and the east line of Sunstone Village No. 1 Subdivision, recorded as Entry No. 7973084 in Plat Book 2001P at Page 224, said point also lying North 00°00'42" East - 40.000 feet from a Salt Lake County monument marking the southwest corner of Section 24, Township 3 South, Range 2 West; thence along the east, north and west lines of phases No. 1 and 2 the following three (3) calls: (1) North 00°00'42" East for 2360.900 feet to the northeast corner of said Sunstone Village No. 1; (2) thence South 89°56'12" West for 1815.000 feet to the northwest corner of said Sunstone Village No. 2; (3) thence South 00°00'42" West for 783.900 feet to a point of intersection of the west line of said Sunstone Village No. 2 and the northeast corner of a 20 acre land swap; thence along the north and west lines of said 20 acre land swap the following two (2) calls: (1) South 89°56'12" West for 550.000 feet; (2) thence South 00°00'42" West for 1577.000 feet to a point on the north right of way line of said 11800 South Street; thence along said north right of way line the following four (4) calls: (1) South 89°56'12" West for 282.340 feet; (2) thence South 89°56'14" West for 2647.809 feet; (3) thence North 89°49'08" West for 2644.258 feet; (4) thence North 89°49'44" West for 1322.052 feet; thence North 00°02'03" East along the west line of the east half of the southwest quarter of section 22 for 2605.414 feet to the northwest corner of the east half of the southwest quarter of said Section 22; thence North 89°47'52" West along the north line of said southwest quarter for 1320.211 feet to a Salt Lake County monument marking the west quarter corner of said Section 22; thence North 00°03'55" East along the west line of said Section 22 for 2645.133 feet to a Salt Lake County monument marking the southwest corner of Section 15; thence North 00°14'20" West along the west line of said Section 15 for 12.748 feet to a point on the east right of way of Highway 111; thence along said east right of way line the following two (2) calls: (1) North 20°34'34" East for 1811.53" (chord bearing and distance of North 03°16'41" East - 928.261 feet) and for an arc distance of 932.174 feet to a point of intersection with said east right of way and the south line of the Trans Jordan Landfill property, recorded as Entry No. 5683985 in Book 6826 at Page 293, from which the southwest corner of said property bears South 89°55'33" West - 2.095 feet; thence North 89°55'33" East along the south line of said landfill property for 4347.905 feet to the southeast corner; thence along the east and northerly boundary of said landfill property the following fourteen (14) calls: (1) North 00°04'22" West for 1075.580 feet; (2) thence North 70°32'11" West for 679.750 feet; (3) thence North 32°28'51" West for 429.340 feet; (4) thence North 25°09'37" West for 219.480 feet; (5) thence North 54°23'20" West for 67.210 feet; (6) thence North 71°54'33" West for 83.160 feet; (7) thence South 87°43'11" West for 366.060 feet; (8) thence South 71°57'46" West for 162.800 feet; (9) thence South 84°04'01" West for 113.990 feet; (10) thence North 87°25'43" West for 89.260 feet; (11) thence North 79°38'44" West for 107.140 feet; (12) thence North 72°57'41" West for 348.270 feet; (13) thence North 78°14'53" West for 465.783 feet; (14) thence South 89°55'33" West for 1887.661 feet to a point on said east right of way of Highway 111; thence along said east right of way the following four (4) calls: (1) North 06°31'26" West for 48.941 feet; (2) thence North 00°48'48" West for 251.250 feet; (3) thence North 06°31'26" West for 687.100 feet to a found Utah Department of Transportation right of way marker; (4) thence with a curve to the right, having a radius of 5654.580 feet, a central angle of 05°38'46" (chord bearing and distance of North 03°42'03" West - 556.992 feet) and for an arc distance of 557.218 feet to a point of intersection of the said east right of way and the south right of way of the Denver and Rio Grande Railroad, recorded in Book 5381 at Page 373; thence leaving Highway 111 and along said Denver and Rio Grande south right of way the following four (4) calls: (1) North 87°56'32" East for 525.105 feet; (2) thence with a curve to the right, having a radius of 5679.650 feet, a central angle of 02°07'45" (chord bearing and distance of North 89°00'25" East - 211.050 feet) and for an arc distance of 211.062 feet; (3) thence South 89°55'43" East for 6588.936 feet; (4) thence North 56°54'49" East for 242.927 feet to a point of intersection with said south right of way and the north line of Section 14, Township 3 South, Range 2 West; thence South 89°55'21" East along the north line of said section for 512.274 feet to a Salt Lake County monument marking the north quarter corner of said Section 14; thence South 89°55'04" East continuing along said north line for 761.295 feet to the northwest corner of the Utah Power and Light parcel recorded in Book 4362 at Page 429; thence along the west and south lines of said U.P. & L. parcel the following two (2) calls: (1) South 00°02'50" West for 940.000 feet; (2) thence South 89°55'04" East for 1890.000 feet to the southeast corner of the Utah Power and Light parcel recorded in Book 4358 at Page 302, said point also lying on the east line of said Section 14; thence North 00°02'50" East along said east line for 940.000 feet to the POINT OF BEGINNING

Containing 189,265, 768.079 Square feet or 4344.9442 Acres

Scale: 1" = 800'

Basis of Bearing is "KEN-TM", a custom Transverse Mercator Coordinate Projection developed by Loyd D. Olsen and defined in the executive brief to Kennecott Development Corporation dated February 2, 2002.

No.	Bearing	Length
L1	S00°15'56"W	33.000'
L2	N89°57'36"E	33.178'
L3	N89°58'34"E	278.761'
L4	S23°56'44"E	634.361'
L5	S60°20'55"W	360.045'
L6	S29°39'05"E	496.250'
L7	N33°11'06"E	98.140'
L8	S89°56'12"W	550.000'
L9	S89°56'12"W	282.340'
L10	N70°32'11"W	679.750'
L11	N32°28'51"W	429.340'
L12	N25°09'37"W	219.480'
L13	N54°23'20"W	67.210'
L14	N71°54'33"W	83.160'
L15	S87°43'11"W	366.060'
L16	S71°57'46"W	162.800'
L17	S84°04'01"W	113.990'
L18	N87°25'43"W	89.260'
L19	N79°38'44"W	107.140'
L20	N72°57'41"W	348.270'
L21	N78°14'53"W	465.783'
L22	N78°14'53"W	407.402'
L23	N00°04'22"W	251.250'
L24	N87°56'32"E	525.105'
L25	N56°54'49"E	242.927'
L26	S89°55'21"E	512.274'
L27	S89°55'21"E	365.605'
L28	N00°08'33"E	409.393'
L29	N00°00'12"E	410.687'
L30	N00°00'12"E	180.702'
L31	N37°29'42"W	1527.114'
L32	N89°58'54"E	138.608'
L33	S37°29'42"E	1299.415'
L34	N00°12'08"W	87.624'
L35	N00°08'33"E	362.400'

LEGEND:

- ◆ Found Salt Lake County Monument
- Set 5/8 Rebar W/Cap LS 358275
- Found UDOT R/W Marker
- ▲ Found Stone Monument
- Found Corner as Noted

Note: No easements of record are shown on this map. Easements of record are depicted on an ALTA survey of this property to be recorded in the Salt Lake County Surveyor's office.

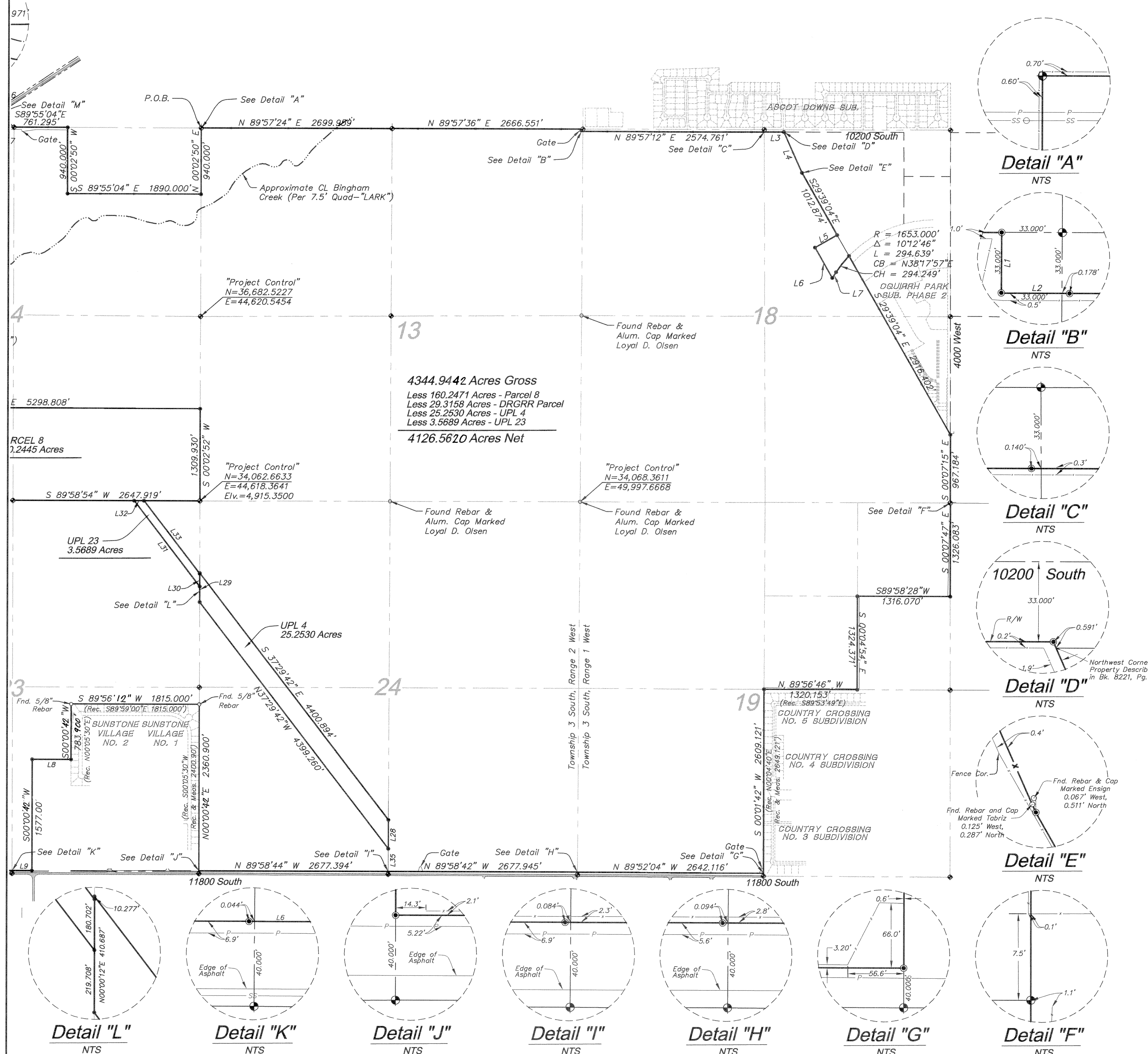

NOLTE
BEYOND ENGINEERING
6671 SOUTH REDWOOD ROAD, SUITE 101 WEST JORDAN, UT 84084
801743.1900 TEL 801743.0300 FAX WWW.NOLTE.COM

SHEET NUMBER
1 OF 6
SCALE
1" = 800'
PROJECT NUMBER
86302000

PLANNING COMMISSION
APPROVED THIS 14th DAY OF May, A.D., 2002 BY THE
SOUTH JORDAN CITY PLANNING COMMISSION.
CHAIRMAN, SOUTH JORDAN PLANNING COMM.

HEALTH
APPROVED AS TO FORM THIS DAY OF _____, A.D., 20____
DIRECTOR, SALT LAKE CO. BOARD OF HEALTH

SOUTH JORDAN CITY ENGINEER
I HEREBY CERTIFY THAT THIS OFFICE HAS EXAMINED THIS PLAT AND IT IS CORRECT IN ACCORDANCE WITH INFORMATION ON FILE IN THIS OFFICE.
DATE 5/9/02 Jessie W. Lawton
SOUTH JORDAN CITY ENGINEER

APPROVAL AS TO FORM
APPROVED AS TO FORM THIS 17th DAY OF May, A.D., 2002
Paul Thompson
SOUTH JORDAN CITY ATTORNEY

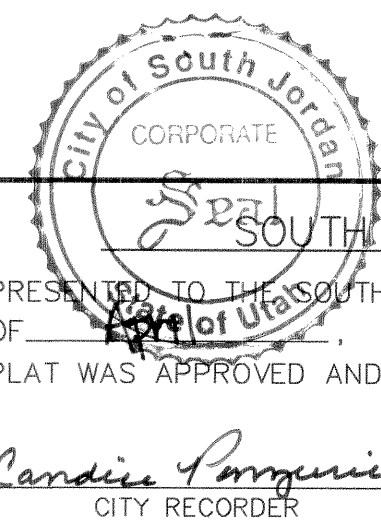

SOUTH JORDAN CITY COUNCIL
PRESENTED TO THE SOUTH JORDAN CITY COUNCIL THIS 10 DAY OF May, A.D., 2002, AT WHICH TIME THIS PLAT WAS APPROVED AND ACCEPTED.
Candice Pommier CITY RECORDER
William Lee Murray MAYOR, CITY OF SOUTH JORDAN

KENNECOTT MASTER SUBDIVISION #1
A TRACT OF LAND SITUATED IN SECTIONS 18 AND 19, TOWNSHIP 3 SOUTH, RANGE 1 WEST, AND SECTIONS 13 14, 15, 22, 23 AND 24, TOWNSHIP 3 SOUTH, RANGE 2 WEST, SALT LAKE BASE AND MERIDIAN SALT LAKE COUNTY, UTAH
RECORDED # **837680**
STATE OF UTAH, COUNTY OF SALT LAKE, RECORDED AND FILED AT THE REQUEST OF: South Jordan
DATE: 04/20/02 TIME: 3:16 PM BOOK: 2002 PAGE: 273
FEE\$ \$201.00
FEE\$ Chiff DEPUTY SALT LAKE COUNTY RECORDER

KENNECOTT MASTER SUBDIVISION #1

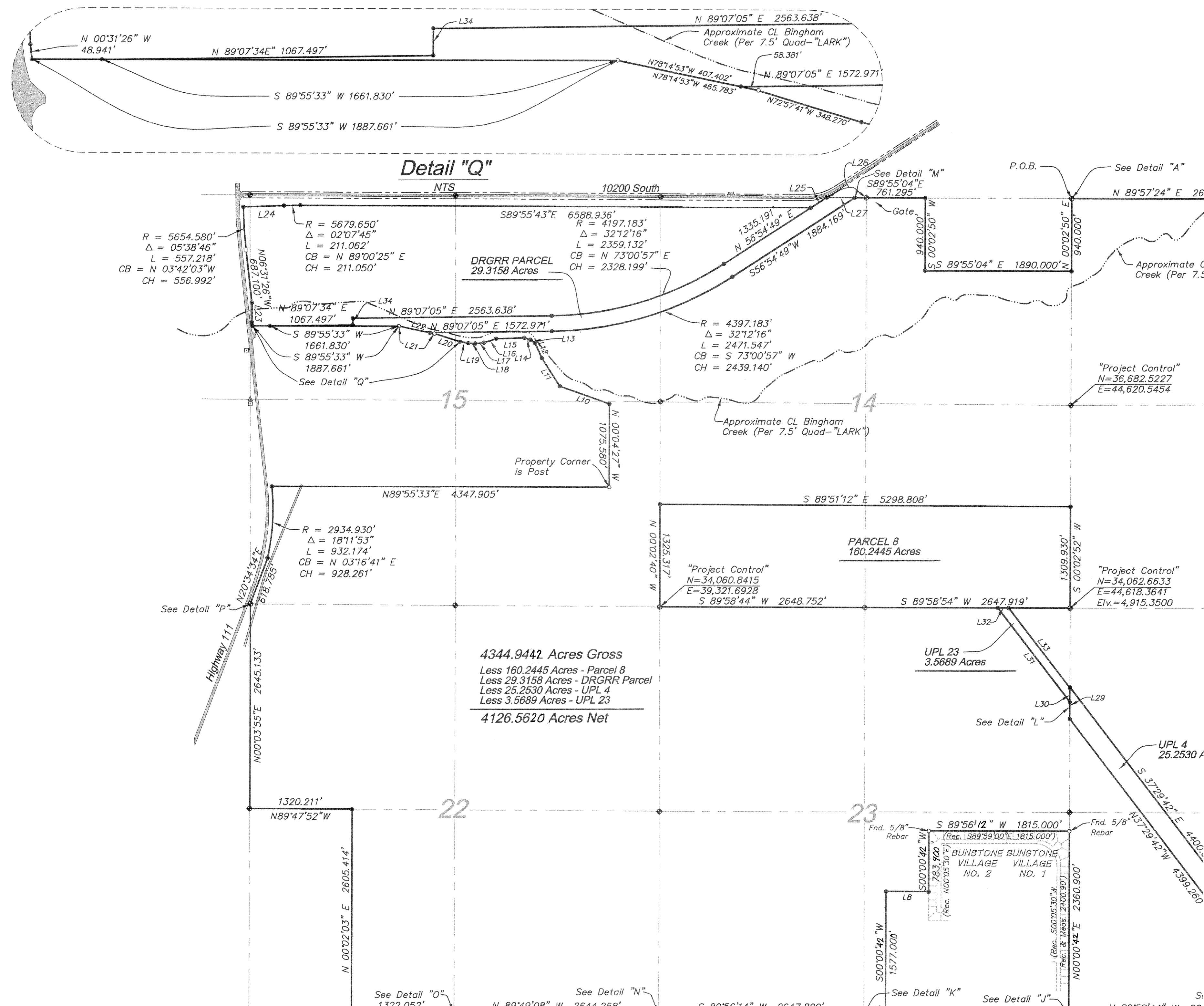

BOUNDARY DESCRIPTION CONTINUED

Less and Except - UPL4
 A tract of land located in the west half of Section 24, Township 3 South, Range 2 West, Salt Lake Base and Meridian, said tract being more particularly described as follows:
 Commencing at the south quarter corner of said Section 24; thence North 00°08'33" East along the east line of said west half for 362.40 feet to the POINT OF BEGINNING, said point marking the south east corner of a tract of land recorded in Book 5015 at Page 420; thence North 37°29'42" West for 4399.260 feet to a point on the west line of said Section 24; thence North 00°00'12" East along said west line for 410.687 feet to a point, from which the northwest corner of said Section 24 bears North 00°00'12" East - 1020.943 feet; thence South 37°29'42" East for 4400.894 feet to a point on the east line of said west half; thence South 00°08'33" West for 409.393 to the POINT OF BEGINNING.

Containing 25.2530 Acres.
 Less and Except - UPL23
 A tract of land located in the northeast quarter of Section 23, Township 3 South, Range 2 West, Salt Lake Base and Meridian, said tract being more particularly described as follows:
 Commencing at the northeast corner of said Section 23; thence South 89°58'54" West along the north line of said section for 791.000 feet to the POINT OF BEGINNING; thence South 37°29'42" East for 1299.415 feet to a point on the east line of said Section 23, from which the northeast corner of said section bears North 00°00'12" East - 1031.220 feet; thence South 00°00'12" West along said east section line for 180.702 feet; thence North 37°29'42" West for 1527.114 feet to a point on the north line of said Section 23; thence North 89°58'54" East along the north line of said section for 138.608 feet to the POINT OF BEGINNING.

Containing 3.5689 Acres.
 Less and Except - Parcel 8
 A tract of land traditionally described as the South 80 rods of Section 14, Township 3 South Range 2 West, Salt Lake base and Meridian, said tract being more particularly described as follows:
 BEGINNING at a Salt Lake County monument marking the southeast corner of said Section 14; thence South 89°58'54" West along the south line of the section for 2647.919 feet to a Salt Lake County monument marking the south quarter corner of said Section 14; thence South 89°58'44" West continuing along the south line of said section for 2648.752 feet to a Salt Lake County monument marking the southwest corner of said Section 14; thence North 00°02'40" West along the west line of said section for 1325.317 feet; thence South 89°51'12" East for 5298.808 feet to a point on the east line of said section; thence South 00°02'52" West along the east line of said section for 1309.930 feet to the POINT OF BEGINNING.

Containing 160.2445 Acres.
 Less and Excepting - DRGRR Parcel
 A tract of land located in the north half of Sections 14 and 15, Township 3 South, Range 2 West, Salt Lake Base and Meridian, said tract being more particularly described as follows:
 Commencing at the north quarter corner of said Section 14; thence North 89°55'21" West along the north line of said Section 14 for 146.669 feet to the POINT OF BEGINNING; thence the following three calls along the south right of way of said railroad: (1) South 56°54'49" West for 1884.169 feet; (2) thence with a curve to the right having a radius of 4397.183 feet, a central angle of 32°12'16" (chord bearing and distance of South 73°00'57" West - 2439.140 feet) and for an arc distance of 2471.547 feet; (3) thence South 89°07'05" West for 1572.971 feet to a point of intersection with the north line of the landfill property; thence along the north line of said landfill property the following two (2) calls: (1) thence North 78°14'54" West for 407.402 feet; (2) thence South 89°55'33" West for 1661.830 feet to a point of intersection with the north right of way of the railroad; thence with said north right of way line the following five (5) calls: (1) North 89°07'34" East for 1067.497 feet; (2) North 00°12'08" West for 87.624 feet; (3) thence North 89°07'05" East for 2563.638 feet; (4) thence with a curve to the left having a radius of 4197.183 feet, a central angle of 32°12'16" (chord bearing and distance of North 73°00'57" East - 2328.199 feet) and for an arc distance of 2359.132 feet; (5) thence North 56°54'49" East for 1578.118 feet to a point on the north line of said Section 14; thence South 89°55'21" East along the north line of said Section 14 for 365.605 feet to the POINT OF BEGINNING.

Containing 29.3158 acres.

No.	Bearing	Length
L1	S00°15'56"W	33.000'
L2	N89°57'36"E	33.178'
L3	N89°58'34"E	278.761'
L4	S23°56'44"E	634.361'
L5	S60°20'55"W	360.045'
L6	S29°39'05"E	496.250'
L7	N33°11'06"E	98.140'
L8	S89°56'12"W	550.000'
L9	S89°56'12"W	282.340'
L10	N70°32'11"W	679.750'
L11	N32°28'51"W	429.340'
L12	N25°09'37"W	219.480'
L13	N54°23'20"W	67.210'
L14	N71°54'33"W	83.160'
L15	S87°43'11"W	366.060'
L16	S71°57'46"W	162.800'
L17	S84°04'01"W	113.990'
L18	N87°25'43"W	89.260'
L19	N79°38'44"W	107.140'
L20	N72°57'41"W	348.270'
L21	N78°14'53"W	465.783'
L22	N78°14'53"W	407.402'
L23	N00°48'48"W	251.250'
L24	N87°56'32"E	525.105'
L25	N56°54'49"E	242.927'
L26	S89°55'21"E	512.274'
L27	S89°55'21"E	365.605'
L28	N00°08'33"E	409.393'
L29	N00°00'12"E	410.687'
L30	N00°00'12"E	180.702'
L31	N37°29'42"W	1527.114'
L32	N89°58'54"E	138.608'
L33	S37°29'42"E	1299.415'
L34	N00°12'08"W	87.624'
L35	N00°08'33"E	362.400'

- LEGEND:**
- Found Salt Lake County Monument
 - Set 5/8 Rebar W/Cap LS 358275
 - Found UDOT R/W Marker
 - ▲ Found Stone Monument
 - Found Corner as Noted

OWNER'S DEDICATION
 Know all men by these presents that WE, the SALT undersigned owner (S) of the above described tract of land, have caused same to be subdivided into parcels to be hereafter known as the
KENNECOTT MASTER SUBDIVISION #1
 In witness whereof I have hereunto set MY HAND this
13th day of MAY A.D. 2002.

P.J. McMahon P.J. McMahon
 PRESIDENT, KDC OM Enterprises
CORPORATE ACKNOWLEDGMENT

STATE OF UTAH } S.S.
 COUNTY OF Salt Lake }
 The foregoing instrument was acknowledged before me this 13th day of May, A.D. 2002 by Peter F. McMahon, the President of Kennecott Developments, Inc. a Delaware Corporation, and OM Enterprises.
 My COMMISSION EXPIRES 2-16-2006
Jolynn M. Tuckett
 NOTARY PUBLIC
 RESIDING IN Salt Lake COUNTY

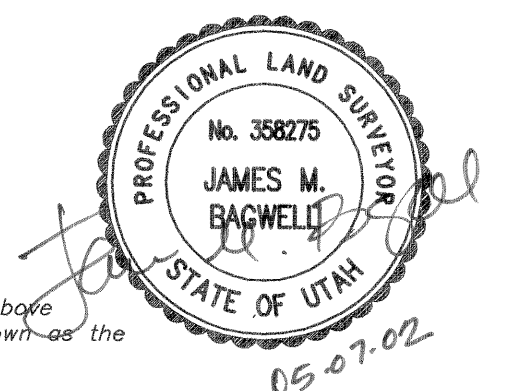

S. Note:
 No easements of record are shown on this map. Easements of record are depicted on an ALTA survey of this property to be recorded in the Salt Lake County Surveyor's office.

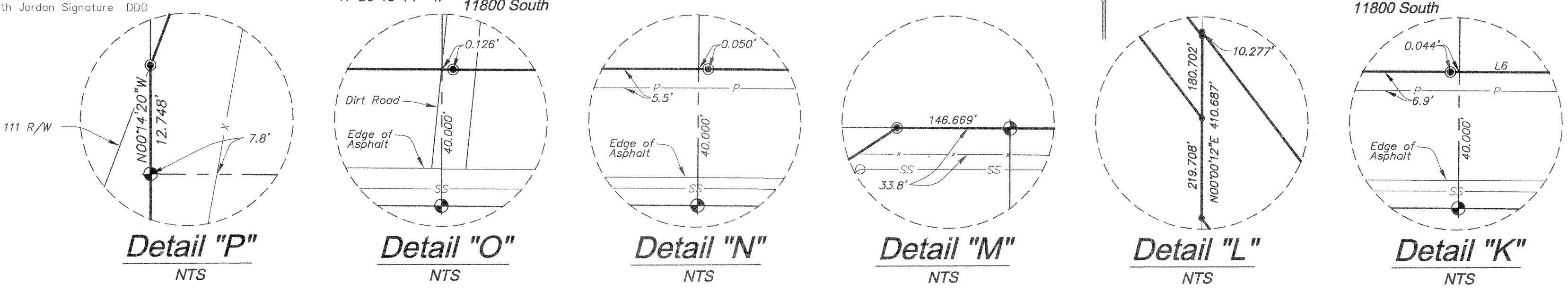

NOLTE
 BEYOND ENGINEERING
 6671 SOUTH REDWOOD ROAD, SUITE 101 WEST JORDAN, UT 84084
 801743.1900 TEL 801743.0300 FAX WWW.NOLTE.COM

SHEET NUMBER	2 OF 6
SCALE	1" = 800'
PROJECT NUMBER	86302000
DATE	5/03/02

PLANNING COMMISSION
 APPROVED THIS 14th DAY OF May, A.D. 2002 BY THE
 SOUTH JORDAN CITY PLANNING COMMISSION.
[Signature]
 CHAIRMAN, SOUTH JORDAN PLANNING COMM.

HEALTH
 APPROVED AS TO FORM THIS DAY OF May, A.D. 2002
[Signature]
 DIRECTOR, SALT LAKE CO. BOARD OF HEALTH

SOUTH JORDAN CITY ENGINEER
 I HEREBY CERTIFY THAT THIS OFFICE HAS EXAMINED THIS PLAT AND IT IS CORRECT IN ACCORDANCE WITH INFORMATION ON FILE IN THIS OFFICE.
 DATE 5/9/02 [Signature]
 SOUTH JORDAN CITY ENGINEER

APPROVAL AS TO FORM
 APPROVED AS TO FORM THIS 17th DAY OF May, A.D. 2002
[Signature]
 SOUTH JORDAN CITY ATTORNEY

CITY OF SOUTH JORDAN
 SOUTH JORDAN CITY COUNCIL
 PRESENTED TO THE SOUTH JORDAN CITY COUNCIL THIS 16 DAY OF May, A.D. 2002, AT WHICH TIME THIS PLAT WAS APPROVED AND ACCEPTED.
[Signatures]
 CITY RECORDER MAYOR, CITY OF SOUTH JORDAN

KENNECOTT MASTER SUBDIVISION #1
 A TRACT OF LAND SITUATED IN SECTIONS 18 AND 19, TOWNSHIP 3 SOUTH, RANGE 1 WEST, AND SECTIONS 13 14, 15, 22, 23 AND 24, TOWNSHIP 3 SOUTH, RANGE 2 WEST, SALT LAKE BASE AND MERIDIAN SALT LAKE COUNTY, UTAH
 RECORDED # 8376820
 STATE OF UTAH, COUNTY OF SALT LAKE, RECORDED AND FILED AT THE REQUEST OF: SOUTH JORDAN
 DATE: 04/20/02 TIME: 3:16PM BOOK: 2002 PAGE: 213
 \$ 201.00 FEES
[Signature]
 CHIEF DEPUTY SALT LAKE COUNTY RECORDER

KENNECOTT MASTER SUBDIVISION #1

KENNECOTT MASTER SUBDIVISION #1

South Jordan, Utah

Master Subdivision Plat

P-C ZONE PLAN LAND USE TABLE

Total Acres	4,127
Open Space Acres (30%)	1,250
Residential Units	13,867
Retail (Square Feet)	2,390,000
Office (Square Feet)	5,185,000
Industrial (Square Feet)	1,500,000

OWNER AND DEVELOPER

Kennecott Development Company
 Chuck Johnson - Real Estate Advisor
 5295 South 300 West
 Suite 475
 Murray, Utah 84107
 Phone (801) 743-4624
 Fax (801) 743-4659

LAND USE LEGEND

1009.71 AC.	T	Town	OS3	Open Space System 3 (See Description Below)
321.30 AC.	B	Business - Research Parkway	OS4	Open Space System 4 (See Description Below)
2174.59 AC.	V	Village		
450.36 AC.	OS	Open Space		
170.59 AC.	WTC	Western Transportation Corridor		
4126.55 AC.		Total Acreage		

ROADWAY SECTIONS

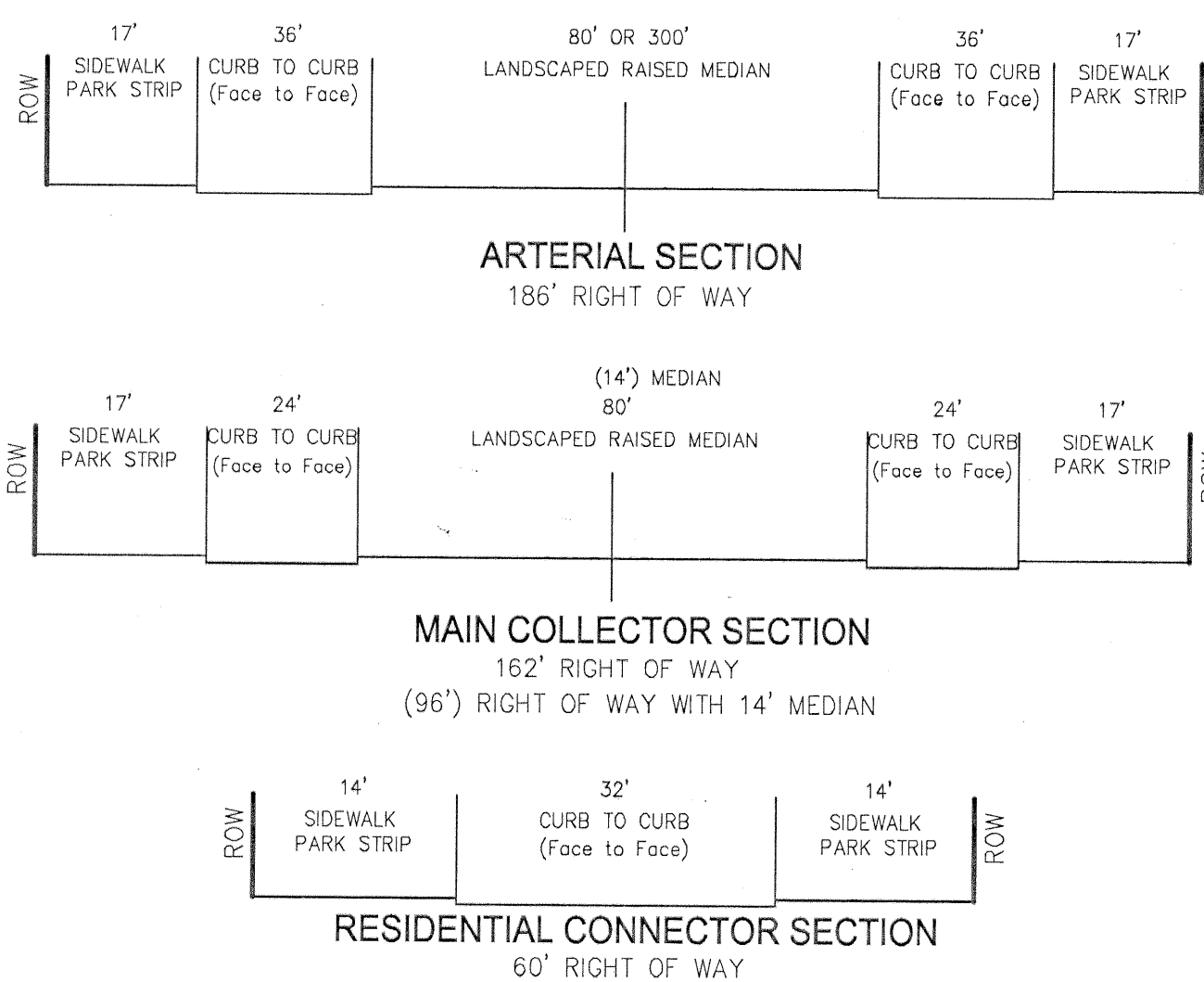

SURVEYORS CERTIFICATE

I, John R. Berry, hereby certify that I am a Registered Land Surveyor, and that I hold License No. 172483 as prescribed under the Laws of the State of Utah. I further certify that by the authority of the Owners I have subdivided the overall parcel, described on Sheets No. 1 and No. 2 of this set of drawings and surveyed by others, into smaller parcels in conformity with the minimum standards and requirements of the law.

John R. Berry
 R.L.S. No. 172483
 Date: 5/17/02

PROJECT PHASING

Phasing of the South Jordan City, Kennecott Master Subdivision #1 will progress by incorporating the requisite housing, office space, retail, commercial, mixed use and industrial development space as the absorption rate for these types of land uses in the Southwest quadrant of the Salt Lake Valley allow.

The initial phases of development will most likely occur where there is adequate highway access and sufficient utility infrastructure already in place. In some of these early points the roadways and utilities may require upgrading or extensions.

Village, Town and Mixed Use phasing starts could occur at the following locations:

- At the East boundary of the project at 10400 South.
- At the East boundary of the project at 11400 South.
- At the North boundary of the project at 4800 West.
- At the South boundary of the project, along 11800 South, entering at approximately 4500 West.
- At the South boundary of the project, along 11800 South, entering at 6000 West.

Roadway access and some utility tie-ins are available at these locations, but will require some upgrades, modifications or additions.

Some Business - Research Parkway starts could occur along the Old Bingham Highway, and are unencumbered by access. Utility tie-ins are available with some required upgrades, modifications or additions.

The Primary Town and Business - Research Parkway starts will be somewhat dependent on the completion of the Western Transportation Corridor through the project.

The designated Open Space systems, adjoining the respective Towns, Businesses - Research Parkways, Villages or Mixed Uses, will be developed in conjunction with these respective land uses as they are completed.

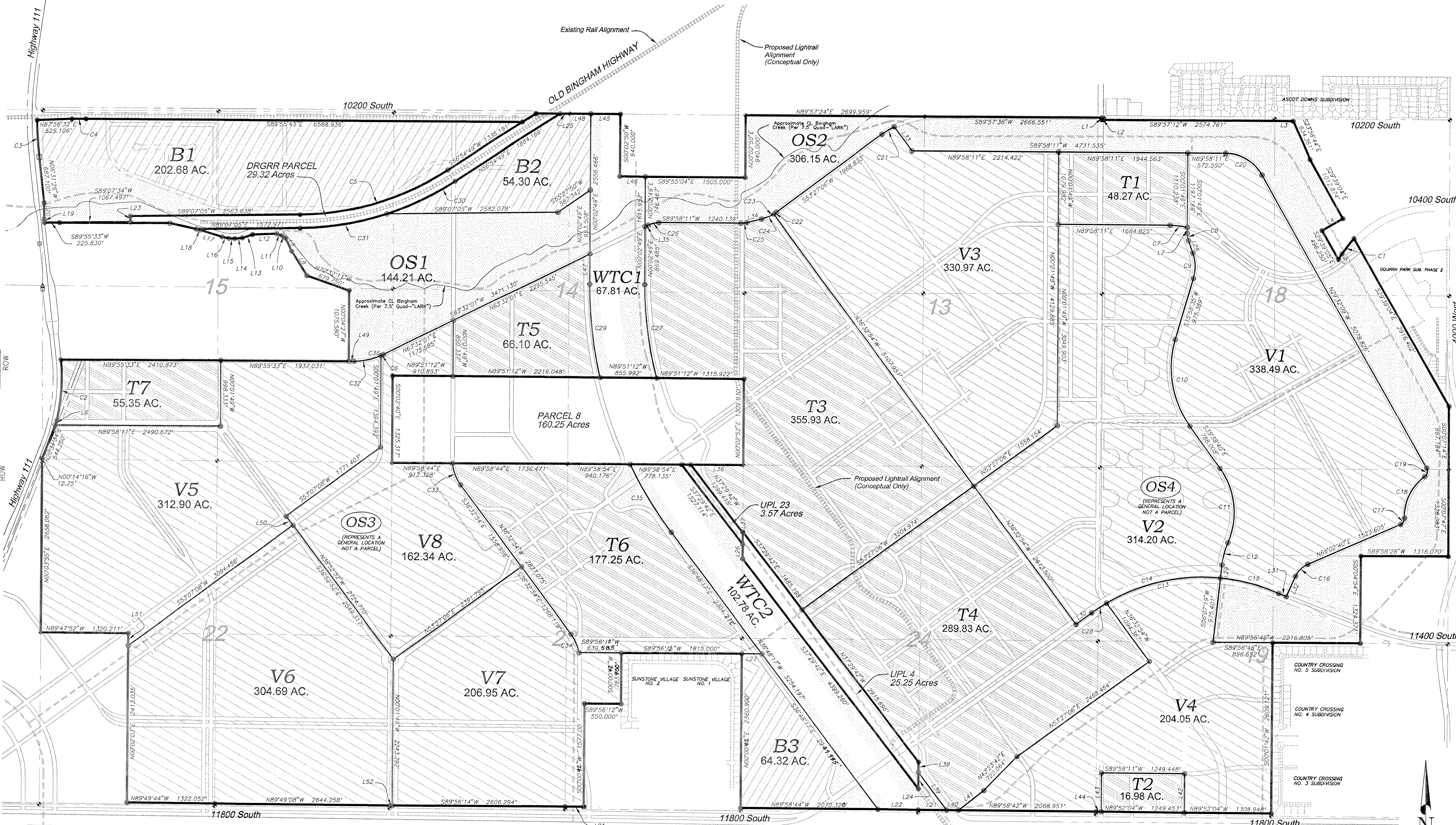

LEGEND

Symbols as designated for lot description by Stantec Consulting

○ Described Lot Corner - "R" Rebar w/cap marked "STANTEC" to be set

OPEN SPACE SYSTEMS DESCRIPTIONS

OS3 (not shown here) - The Open Space Systems for area OS3 will generally be represented by the functions of a minimum 25 acre regional park which will accommodate a variety of uses from active recreational playfields and ball diamonds, playgrounds, soccer fields and pavilions, to passive recreational walking trails and picnic areas. This open space is to be centrally located in the West Village.

OS4 (not shown here) - The Open Space Systems for area OS4 will generally be represented by the functions of a minimum 25 acre regional park which will accommodate a variety of uses from active recreational playfields and man made water features to passive recreational walking trails and picnic areas. This open space is to be centrally located in the East Village.

The Open Space designations OS3 and OS4 are not synonymous with any Village, Town or Business-Research Park (V1, T1 or B1) land use designations.

ADDRESS TABLE

PARCEL	PARCEL ADDRESS
B1	6800 WEST 10200 SOUTH
B2	6200 WEST 10200 SOUTH
B3	5400 WEST 11800 SOUTH
T1	4600 WEST 10400 SOUTH
T2	4700 WEST 11800 SOUTH
T3	5400 WEST 10900 SOUTH
T4	5000 WEST 11800 SOUTH
T5	6200 WEST 10900 SOUTH
T6	5800 WEST 11200 SOUTH
T7	7000 WEST 10900 SOUTH
V1	4400 WEST 11000 SOUTH
V2	4600 WEST 11000 SOUTH
V3	5000 WEST 10800 SOUTH
V4	4500 WEST 11800 SOUTH
V5	6800 WEST 11200 SOUTH
V6	6800 WEST 11800 SOUTH
V7	6200 WEST 11800 SOUTH
V8	6400 WEST 11200 SOUTH
WTC1	5900 WEST 10200 SOUTH
WTC2	2500 WEST 11800 SOUTH
OS1	6400 WEST 10800 SOUTH
OS2	4400 WEST 10200 SOUTH

LINE TABLE

LINE	BEARING	LENGTH
L1	S00°15'56"W	33.000'
L2	N89°57'36"E	33.178'
L3	N89°58'34"E	278.781'
L4	S60°20'55"W	360.045'
L5	N33°11'00"E	88.042'
L6	N20°34'34"W	249.895'
L7	S00°01'49"E	86.948'
L8	N32°28'51"W	428.340'
L9	N25°02'37"W	219.480'
L10	N54°23'20"W	67.210'
L11	N71°54'33"W	63.180'
L12	S87°43'11"W	368.090'
L13	S71°57'46"W	162.800'
L14	S84°04'01"W	113.990'
L15	N07°24'43"W	89.260'
L16	N79°38'44"W	107.140'
L17	N72°57'41"W	348.270'
L18	N78°14'53"W	58.381'
L19	N08°31'28"W	48.941'
L20	N00°48'48"W	251.260'
L21	S89°58'14"W	282.246'
L22	S89°58'14"W	607.073'
L23	S90°12'08"E	87.824'
L24	N00°08'33"E	249.895'
L25	S89°55'21"E	146.689'
L26	S00°00'12"W	219.708'
L27	N89°56'12"E	202.631'
L28	S19°19'36"E	193.436'
L29	S00°30'09"W	204.756'
L30	S83°27'06"W	294.958'
L31	S68°14'35"E	123.220'
L32	N2°24'29"E	343.311'
L33	N36°32'54"W	456.521'
L34	S76°05'06"W	229.999'
L35	S63°32'01"W	52.044'
L36	N89°58'34"E	791.000'
L37	S00°00'12"W	10.277'
L38	N00°08'33"E	159.498'
L39	S38°48'17"E	714.963'
L40	N89°58'42"W	179.199'
L41	N51°10'19"E	486.575'
L42	N00°01'49"W	583.755'
L43	S00°01'49"E	590.214'
L44	N89°52'04"W	83.715'
L45	S89°55'04"E	445.000'
L46	N89°55'04"W	385.000'
L47	N00°02'49"E	455.422'
L48	S89°55'04"E	316.294'
L49	S89°55'33"W	78.600'
L50	S36°52'52"E	175.453'
L51	N00°32'03"E	182.379'
L52	S89°56'14"W	41.915'

CURVE TABLE

CURVE	RADIUS	LENGTH	DELTA	CHORD BEARING	CHORD
C1	1653.000'	294.639'	101°24'48"	N38°17'57"E	284.249'
C2	2934.830'	932.187'	18°11'52"	N03°10'41"E	926.281'
C3	5654.580'	557.221'	5°38'46"	N03°44'03"W	556.993'
C4	5679.850'	211.061'	2°07'45"	N89°00'28"E	211.049'
C5	4187.183'	2359.126'	32°12'16"	S73°00'57"W	2328.199'
C6	1000.000'	38.527'	21°27'26"	N84°38'14"E	38.523'
C7	1130.000'	262.081'	131°17'19"	N83°23'09"W	261.494'
C8	330.000'	111.140'	18°17'47"	S09°40'42"E	110.615'
C9	630.000'	388.177'	33°31'11"	S01°40'31"E	382.086'
C10	1530.000'	1378.459'	31°37'15"	S09°50'03"E	1332.309'
C11	1170.000'	1194.802'	58°30'02"	S06°23'39"E	1143.385'
C12	1180.000'	350.531'	17°01'13"	S14°20'46"W	349.242'
C13	2817.800'	1787.813'	39°21'24"	N72°02'52"E	1753.866'
C14	2817.800'	2056.236'	41°46'27"	S74°20'19"W	2009.038'
C15	2817.800'	911.261'	18°31'52"	S72°30'31"E	887.288'
C16	360.000'	268.700'	42°11'45"	S44°54'38"W	269.710'
C17	100.000'	120.614'	69°06'24"	N31°28'28"E	113.430'
C18	740.000'	731.911'	58°40'10"	N25°18'21"E	702.440'
C19	100.000'	145.112'	83°08'35"	N12°02'08"E	132.711'
C20	630.000'	665.171'	60°29'40"	N59°46'59"W	634.701'
C21	1430.000'	218.537'	8°45'22"	S57°49'47"W	218.327'
C22	630.000'	49.633'	4°30'50"	N54°42'31"E	49.621'
C23	630.000'	248.869'	22°38'01"	S64°46'06"W	247.254'
C24	360.000'	189.234'	18°07'10"	N87°01'31"E	189.406'
C25	360.000'	87.240'	13°53'04"	N83°01'39"E	87.027'
C26	360.000'	166.103'	26°26'11"	S76°45'06"W	164.635'
C27	5465.000'	1441.676'	15°06'53"	N07°30'38"W	1437.499'
C28	2817.800'	268.417'	5°25'06"	N56°09'38"E	266.327'
C29	6295.000'	1435.942'	13°04'11"	S06°29'17"E	1432.830'
C30	4397.183'	1140.243'	14°51'27"	N64°20'32"E	1137.050'
C31	4397.183'	1331.297'	17°20'49"	N80°26'40"E	1326.226'
C32	1000.000'	422.106'	24°11'06"	N77°50'00"E	418.979'
C33	630.000'	354.997'	32°15'51"	S20°25'58"E	349.744'
C34	680.000'	313.436'	26°01'36"	N23°32'01"W	310.742'
C35	6295.000'	174.871'	11°03'27"	S31°16'14"E	173.010'
C36	1000.000'	460.633'	26°23'32"	S76°43'47"W	456.571'

PLANNING COMMISSION

APPROVED THIS 14th DAY OF May, A.D., 2002, BY THE SOUTH JORDAN CITY PLANNING COMMISSION.

CHAIRMAN, SOUTH JORDAN PLANNING COMM.

HEALTH

APPROVED AS TO FORM THIS DAY OF May, A.D., 2002.

DIRECTOR, SALT LAKE CO. BOARD OF HEALTH

SOUTH JORDAN CITY ENGINEER

I HEREBY CERTIFY THAT THIS OFFICE HAS EXAMINED THIS PLAN AND IT IS CORRECT IN ACCORDANCE WITH INFORMATION ON FILE IN THIS OFFICE.

5/9/02
 DATE
 Julie W. Clawson
 SOUTH JORDAN CITY ENGINEER

APPROVAL AS TO FORM

APPROVED AS TO FORM THIS 17th DAY OF May, A.D., 2002.

Paul Taylor
 SOUTH JORDAN CITY ATTORNEY

SOUTH JORDAN CITY COUNCIL

PRESENTED TO THE SOUTH JORDAN CITY COUNCIL THIS 10th DAY OF April, A.D., 2002, AT WHICH TIME THIS PLAN WAS APPROVED AND ACCEPTED.

City Recorder
 Mayor, City of South Jordan

KENNECOTT MASTER SUBDIVISION #1

A TRACT OF LAND SITUATED IN SECTIONS 18 AND 19, TOWNSHIP 3 SOUTH, RANGE 1 WEST, AND SECTIONS 13, 14, 15, 22, 23 AND 24, TOWNSHIP 3 SOUTH, RANGE 2 WEST, SALT LAKE BASE AND MERIDIAN SALT LAKE COUNTY, UTAH

RECORDED # 8376820

STATE OF UTAH, COUNTY OF SALT LAKE, RECORDED AND FILED AT THE REQUEST OF: SOUTH JORDAN

DATE: 04/2002 TIME: 3:16 PM BOOK: 2002 PAGE: 273

FEES \$201.00

Clarence Redding
 DEPUTY SALT LAKE COUNTY RECORDER

1	Issue for South Jordan Signature	JRB	5/07/02
0	South Jordan Submittal	CLR	3/12/02
No.	Revisions	By	Date

Stantec Consulting Inc.
 3995 S 700 E Ste. 300
 Salt Lake City, UT 84107-2540
 Tel. 801.261.0090
 Fax. 801.266.1671
 www.stantec.com

SHEET NUMBER	3 OF 6
SCALE	1" = 800'
PROJECT NUMBER	86302000

KENNECOTT DEVELOPMENT STANDARDS MATRIX LAND USE AND BUILDING DESIGN CRITERIA

KENNECOTT MASTER SUBDIVISION #1

RESIDENTIAL BUILDING TYPES

NON-RESIDENTIAL BUILDING TYPES

	I. SINGLE FAMILY						II. MULTI-FAMILY			III. MIXED USE	IV. SMALL COMMERCIAL	V. LARGE COMMERCIAL	VI. INDUSTRIAL
	A. TOWNHOUSE	B. GREEN COURT/ FLAG LOT	C. SMALL LOT	D. STANDARD LOT	E. LARGE LOT	F. ESTATE	A. GARDEN MULTI-FAMILY	B. TUCK-UNDER MULTI-FAMILY	C. PODIUM MULTI-FAMILY	Mixed use buildings including residential over retail, office over retail, live-work, and residential over office uses. May be any size or height as long as it meets the requirements below.	Non-residential buildings, not including industrial or warehouse uses, that are less than 20,000 sq. ft. Typical types include small retail, service or office buildings of single to three-story height.	Non-residential buildings, not including industrial or warehouse uses, that are larger than 20,000 sq. ft. Typical types include single story retail, or multiple story institutional, or office buildings. 'Big Box' retail is included in this category.	Industrial/R + D buildings are a non-residential building type housing research and development, light production, warehousing, and distribution uses, and related activities.
1	Single-family, duplex, town house, and row house residential units that do not stack dwellings on a single parcel. Typically each unit has a private parcel that has street frontage and contains its own parking, with a one-to-three story height.						Multi-unit residential buildings with two or more dwellings in which units are stacked vertically. Some buildings may be street fronting while others may not. Heights range from two story through high-rise.						
2	DIMENSIONS						LOT COVERAGE						
3	BUILDING SETBACKS AND HEIGHT RESTRICTIONS						BUILDING SETBACKS AND HEIGHT RESTRICTIONS						
4	BUILDING MATERIALS						BUILDING MATERIALS						
5	GARAGE, PARKING LOT AND ACCESS PLACEMENT STANDARDS						GARAGE, PARKING LOT AND ACCESS PLACEMENT STANDARDS						
1	> Min. 15' lot frontage/unit	> Min. 30' lot frontage; 15' min. for attached dwellings	> Min. 40' lot frontage	> Min. 55' lot frontage	> Min. 75' lot frontage	> Min. 90' lot frontage	> Min. 90' lot frontage	> Min. 50' lot frontage	> Min. 90' lot frontage	> Min. 90' lot frontage	n/a	n/a	> Min. 1 acre lot size
2	> Min. 60' lot depth	> Min. 70' lot depth; 60' for attached dwellings.	> Min. 90' lot depth	> Min. 90' lot depth	> Min. 90' lot depth	> Min. 90' lot depth	> Min. 10,000 sq. ft. lot size	> Min. 10,000 sq. ft. lot size	> Min. 10,000 sq. ft. lot size	> Min. 36 sq. ft. per unit private usable open space plus min. 50 sq. ft. per unit common usable open space.	> Min. 36 sq. ft. per unit private usable open space plus min. 50 sq. ft. per unit common usable open space.	> Min. 36 sq. ft. per unit private usable open space plus min. 50 sq. ft. per unit common usable open space.	> Min. 1 acre lot size
3	> Min. setbacks for main building: 5' front, 4' rear. Side setbacks must be 3' min. or 6' from adjacent building. Garages are not included in rear setback calculations.	> Min. setbacks for main building: 5' front, 4' rear. Side setbacks must be 3' min. or 6' from adjacent building. Garages are not included in rear setback calculations.	> Min. setbacks for main building: 10' front, 10' rear. Side setbacks must be 3' min. or 6' from adjacent building. Garages are not included in rear setback calculations.	> Min. setbacks for main building: 10' front, 5' each side, 20' rear. Garages are not included in rear setback calculations.	> Min. setbacks for main building: 12' front, 5' each side, 20' rear. Garages are not included in rear setback calculations.	> Min. setbacks for main building: 16' front, 6' each side, 30' rear. Garages are not included in rear setback calculations.	> Min. setbacks: 10' front, 10' each side, 4' to rear lot line. Where lots are not separated by an alley, buildings must have a min. 15' rear setback.	> Min. setbacks: 10' front, 10' each side, 4' to rear lot line. Where lots are not separated by an alley, buildings must have a min. 15' rear setback.	> Min. setbacks: 10' front, 10' each side, 4' to rear lot line. Where lots are not separated by an alley, buildings must have a min. 15' rear setback.	> Min. setbacks: 0' front, 0' sides, 10' rear.	> Min. setbacks: 0' front, 0' sides, 10' rear.	> Min. setbacks: 0' front, 20' sides, 20' rear. Where lots are not separated by an alley, buildings must have a min. 40' rear setback.	> Min. setbacks: 20' front, 0' side, 0' rear.
4	> For corner lots, side setback min. 5'	> For corner lots, side setbacks min. 5'	> For corner lots, side setbacks min. 6'	> For corner lots, side setback min. 10'	> For corner lots, side setback min. 12'	> For corner lots, side setback min. 16'	> Corner lots are considered to have two front sides	> Corner lots are considered to have two front sides	> Corner lots are considered to have two front sides	> Corner lots are considered to have two front sides	> Corner lots are considered to have two front sides	> For corner lots, side setback min. 0'	
5	> Porches, balconies and bays may encroach beyond front setback lines	> Porches, balconies and bays may encroach beyond front setback lines	> Porches, balconies and bays may encroach beyond front setback lines	> Porches, balconies and bays may encroach beyond front setback lines	> Porches, balconies and bays may encroach beyond front setback lines	> Porches, balconies and bays may encroach beyond front setback lines	> Upper-story balconies and bays may encroach beyond front setback lines	> Upper-story balconies and bays may encroach beyond front setback lines	> Upper-story balconies and bays may encroach beyond front setback lines	> Upper-story balconies and bays may encroach beyond front setback lines	> Upper-story balconies and bays may encroach beyond front setback lines	> Where Industrial parcels abut residential uses, side and rear setback min. 30'.	
6	> 60% of lot frontage must have building w/in 5' of min. setback	> 60% of lot frontage must have building w/in 5' of min. setback	> 40% of lot frontage must have building w/in 5' of min. setback	> 40% of lot frontage must have building w/in 5' of min. setback	> 40% of lot frontage must have building w/in 5' of min. setback	> 40% of lot frontage must have building w/in 5' of min. setback	> 60% of lot frontage must have building within 5' of min. setback	> 60% of lot frontage must have building within 5' of min. setback	> 60% of lot frontage must have building within 5' of min. setback	> 75% of lot frontage must have building w/in 5' of min. setback	> 60% of lot frontage must have building w/in 5' of min. setback	> For non-retail buildings, 60% of lot frontage must have building w/in 10' of min. setback. For retail buildings there is no frontage requirement.	
7	> Siding: Brick, stone, stucco, fiber-reinforced cement board, stained or painted shingles, or wood boards are preferred. Metal panels and plywood are not allowed. Painted wood siding is excluded, but painted accents and painted fiber-reinforced cement board are allowable.	> Siding: Brick, stone, stucco, fiber-reinforced cement board, stained or painted shingles, or wood boards are preferred. Metal panels and plywood are not allowed. Painted wood siding is excluded, but painted accents and painted fiber-reinforced cement board are allowable.	> Siding: Brick, stone, stucco, fiber-reinforced cement board, stained or painted shingles, or wood boards are preferred. Metal panels and plywood are not allowed. Painted wood siding is excluded, but painted accents and painted fiber-reinforced cement board are allowable.	> Siding: Brick, stone, stucco, fiber-reinforced cement board, stained or painted shingles, or wood boards are preferred. Metal panels and plywood are not allowed. Painted wood siding is excluded, but painted accents and painted fiber-reinforced cement board are allowable.	> Siding: Brick, stone, stucco, fiber-reinforced cement board, stained or painted shingles, or wood boards are preferred. Metal panels and plywood are not allowed. Painted wood siding is excluded, but painted accents and painted fiber-reinforced cement board are allowable.	> Siding: Brick, stone, stucco, fiber-reinforced cement board, stained or painted shingles, or wood boards are preferred. Metal panels and plywood are not allowed. Painted wood siding is excluded, but painted accents and painted fiber-reinforced cement board are allowable.	> Siding: Brick, stone, stucco, fiber-reinforced cement board, stained shingles, wood boards, metal, tile or EIFS (Exterior Insulated Finished System) are preferred. Architectural CMU is allowed as an accent. Metal panels and plywood are not allowed. Painted wood siding is excluded, but painted accents and painted fiber-reinforced cement board are allowable.	> Siding: Brick, stone, stucco, fiber-reinforced cement board, stained shingles, wood boards, metal, tile or EIFS (Exterior Insulated Finished System) are preferred. Architectural CMU is allowed as an accent. Metal panels and plywood are not allowed. Painted wood siding is excluded, but painted accents and painted fiber-reinforced cement board are allowable.	> Siding: Brick, stone, stucco, fiber-reinforced cement board, stained shingles, wood boards, metal, tile or EIFS (Exterior Insulated Finished System) are preferred. Architectural CMU is allowed as an accent. Metal panels and plywood are not allowed. Painted wood siding is excluded, but painted accents and painted fiber-reinforced cement board are allowable.	> Siding: Brick, stone, stucco, fiber-reinforced cement board, stained shingles, wood boards, metal, architectural CMU, tile, cast concrete, or EIFS (Exterior Insulated Finished System) are preferred. Plywood is not allowed. Painted wood siding is excluded, but painted accents and painted fiber-reinforced cement board are allowable.	> Siding: Brick, stone, stucco, fiber-reinforced cement board, stained shingles, wood boards, metal, architectural CMU, tile, cast concrete, EIFS (Exterior Insulated Finished System), stucco, or tilt-up concrete construction with textured exterior surface are preferred. Plywood is not allowed. Painted wood siding is excluded, but painted accents and painted fiber-reinforced cement board are allowable.	> Siding: Brick, stone, stucco, fiber-reinforced cement board, stained shingles, wood boards, metal, architectural CMU, tile, cast concrete, EIFS (Exterior Insulated Finished System), stucco, or tilt-up concrete construction with textured exterior surface are preferred. Plywood is not allowed. Painted wood siding is excluded, but painted accents and painted fiber-reinforced cement board are allowable.	
8	> Roofing: Built-up roofing with parapet, architectural shingles, metal shingles, standing seam metal or cement, clay or slate tile are preferred. Wood shingles are not allowed.	> Roofing: Architectural shingles, metal shingles, standing seam metal or cement, clay or slate tile are preferred. Wood shingles are not allowed.	> Roofing: Architectural shingles, metal shingles, standing seam metal or cement, clay or slate tile are preferred. Wood shingles are not allowed.	> Roofing: Architectural shingles, metal shingles, standing seam metal or cement, clay or slate tile are preferred. Wood shingles are not allowed.	> Roofing: Architectural shingles, metal shingles, standing seam metal or cement, clay or slate tile are preferred. Wood shingles are not allowed.	> Roofing: Architectural shingles, metal shingles, standing seam metal or cement, clay or slate tile are preferred. Wood shingles are not allowed.	> Roofing: Built up roofing with parapets, architectural shingles, metal shingles, standing seam metal or cement, clay or slate tile are preferred. Wood shingles are not allowed.	> Roofing: Built up roofing with parapets, architectural shingles, metal shingles, standing seam metal or cement, clay or slate tile are preferred. Wood shingles are not allowed.	> Roofing: Built up roofing with parapets, architectural shingles, metal shingles, standing seam metal or cement, clay or slate tile are preferred. Wood shingles are not allowed.	> Roofing: Built up roofing with parapets, architectural shingles, metal shingles, standing seam metal or cement, clay or slate tile are preferred. Wood shingles are not allowed.	> Roofing: Built up roofing with parapets, architectural shingles, metal shingles, standing seam metal or cement, clay or slate tile are preferred. Wood shingles are not allowed.	> Roofing: Parapet with flat roof required. Mechanical screens required. Wood shingles are not allowed.	> Roofing: Parapet with flat roof required. Mechanical screens required. Wood shingles are not allowed.
9	> Glazing: No reflective glass or mill finished aluminum.	> Glazing: No reflective glass or mill finished aluminum.	> Glazing: No reflective glass or mill finished aluminum.	> Glazing: No reflective glass or mill finished aluminum.	> Glazing: No reflective glass or mill finished aluminum.	> Glazing: No reflective glass or mill finished aluminum.	> Glazing: No reflective glass or mill finished aluminum.	> Glazing: No reflective glass or mill finished aluminum.	> Glazing: No reflective glass or mill finished aluminum.	> Glazing: No reflective glass for residential uses. Minimum 75% visible transmittance (VT) for the ground floor, 50% for upper floor non-residential uses.	> Glazing: Minimum 75% VT ground floor, 50% upper floors.	> Glazing: Minimum 75% VT ground floor, 50% upper floors.	
10	> Materials not listed here shall be subject to review.	> Materials not listed here shall be subject to review.	> Materials not listed here shall be subject to review.	> Materials not listed here shall be subject to review.	> Materials not listed here shall be subject to review.	> Materials not listed here shall be subject to review.	> Materials not listed here shall be subject to review.	> Materials not listed here shall be subject to review.	> Materials not listed here shall be subject to review.	> Materials not listed here shall be subject to review.	> Materials not listed here shall be subject to review.	> Materials not listed here shall be subject to review.	
11	> Each unit requires 1 parking space, which must be enclosed	> Each unit requires 2 parking spaces, 1 of which must be enclosed	> Each unit requires 2 parking spaces, 1 of which must be enclosed	> Each unit requires 2 parking spaces, 1 of which must be enclosed	> Each unit requires 2 parking spaces, 1 of which must be enclosed	> Each unit requires 2 parking spaces, 1 of which must be enclosed	> Each unit requires 1.5 parking spaces. Parking ratio may be decreased to 1 space/3 units plus 1 space per employee for senior housing, or 1 space/unit if the building is within 1/4 mile of a LRT stop.	> Each unit requires 1.5 parking spaces. Parking ratio may be decreased to 1 space/3 units plus 1 space per employee for senior housing, or 1 space/unit if the building is within 1/4 mile of a LRT stop.	> Each unit requires 1.5 parking spaces. Parking ratio may be decreased to 1 space/3 units plus 1 space per employee for senior housing, or 1 space/unit if the building is within 1/4 mile of a LRT stop.	> Min parking ratio: 3 spaces/1000 sq. ft.	> Min parking ratio: 3 spaces/1000 sq. ft.	> Min parking ratio: 3 spaces/1000 sq. ft.	
12	> Parking spaces must be alley-accessed	> Parking spaces may be accessed by alley or common drive.	> Parking spaces may be accessed by alley or side drive.	> Parking spaces may be accessed by alley, side, or front drive	> Parking spaces may be accessed by alley, side, or front drive	> Parking spaces may be accessed by alley, side, or front drive	> Shared parking is allowed	> Shared parking is allowed	> Shared parking is allowed	> Shared parking is allowed	> Shared parking is allowed	> Shared parking is allowed	
13	> Front-loaded garages may be max. 45% of primary facade, and must be recessed 5' behind the primary facade.	> Front-loaded garages may be max. 45% of primary facade, and must be recessed 5' behind the primary facade.	> Front-loaded garages may be max. 40% of primary facade, and must be recessed 5' behind the primary facade.	> Front-loaded garages may be max. 40% of primary facade, and must be recessed 5' behind the primary facade.	> Front-loaded garages may be max. 40% of primary facade, and must be recessed 5' behind the primary facade.	> Front-loaded garages may be max. 40% of primary facade, and must be recessed 5' behind the primary facade.	> Side area parking lots must exceed the building setback by at least 10'. Side area parking shall never be located on a block corner.	> Side area parking lots must exceed the building setback by at least 10'. Side area parking shall never be located on a block corner.	> Side area parking lots must exceed the building setback by at least 10'. Side area parking shall never be located on a block corner.	> Side area parking lots must exceed the building setback by at least 10'. Side area parking shall never be located on a block corner.	> Side area parking lots must not project in front of the building facade. Side area parking shall never be located on a block corner.	> The ground floor of street-facing parking structures must be screened by inhabited space.	

NOTE The Kennecott Development Standards Matrix on Sheets 4 through 6 of this Kennecott Master Subdivision #1, are intended by the City of South Jordan and OM Enterprises Company, the owner of the land identified as Kennecott Master Subdivision #1 (as described in the Boundary Description included on Sheets 1 and 2 of this Master Subdivision Plat), to govern all future development, improvement or alterations of said land or improvements thereon, and to run with said land in perpetuity and be binding on existing and successive owners and interest holders of said land.

KENNECOTT MASTER SUBDIVISION #1
 A TRACT OF LAND SITUATED IN SECTIONS 18 AND 19, TOWNSHIP 3 SOUTH, RANGE 1 WEST, AND SECTIONS 13 14, 15, 22, 23 AND 24, TOWNSHIP 3 SOUTH, RANGE 2 WEST, SALT LAKE BASE AND MERIDIAN SALT LAKE COUNTY, UTAH

RECORDED # 8374820
 STATE OF UTAH, COUNTY OF SALT LAKE, RECORDED AND FILED AT THE REQUEST OF: SOUTH JORDAN
 DATE: 10/1/2002 TIME: 3:16PM BOOK: 2020 PAGE: 273
 FEE\$ \$20.00
 CHIEF DEPUTY SALT LAKE COUNTY RECORDER

Calthorpe Associates
 URBAN DESIGNERS PLANNERS ARCHITECTS

SHEET NUMBER 4 OF 6
 SCALE NA
 PROJECT NUMBER A
 Issue for South Jordan Signature KJW 5/03/02
 Revisions By Date

PLANNING COMMISSION
 APPROVED THIS 14th DAY OF May A.D., 2002 BY THE
 SOUTH JORDAN CITY PLANNING COMMISSION.
 CHAIRMAN, SOUTH JORDAN PLANNING COMM.

HEALTH
 APPROVED AS TO FORM THIS DAY OF _____ A.D., 20____
 DIRECTOR, SALT LAKE CO. BOARD OF HEALTH

SOUTH JORDAN CITY ENGINEER
 I HEREBY CERTIFY THAT THIS OFFICE HAS EXAMINED THIS PLAT AND IT IS CORRECT IN ACCORDANCE WITH INFORMATION ON FILE IN THIS OFFICE.
 DATE 5/9/02 Leslie W. Clauson SOUTH JORDAN CITY ENGINEER

APPROVAL AS TO FORM
 APPROVED AS TO FORM THIS 17th DAY OF May A.D., 2002
 SOUTH JORDAN CITY ATTORNEY

SOUTH JORDAN CITY COUNCIL
 PRESENTED TO THE SOUTH JORDAN CITY COUNCIL THIS 16 DAY OF April A.D., _____, AT WHICH TIME THIS PLAT WAS APPROVED AND ACCEPTED.
 CITY RECORDER
 MAYOR, CITY OF SOUTH JORDAN

KENNECOTT DEVELOPMENT STANDARDS MATRIX

OPEN SPACE SYSTEM

KENNECOTT MASTER SUBDIVISION #1

	INTENT	RIPARIAN/STREAM	NATIVE HILLSIDES	TRANSPORTATION CORRIDOR	PARKWAYS	REGIONAL PARK	NEIGHBORHOOD PARKS	POCKET PARKS
PRINCIPLES	<ul style="list-style-type: none"> The open space system is an integrated network of natural and man-made landscapes. This network provides for many differing landscape typologies that range from existing stream corridors to manicured neighborhood parks. Each landscape typology is connected with the others through a comprehensive on and off-street trail and pathway system. The design of open space system seeks to express the environmental and cultural conditions of the community. 	<ul style="list-style-type: none"> The riparian/stream zone is located along the Bingham Creek corridor. The zone will be characterized by enhanced riparian vegetation along the existing stream bed and existing and enhanced native or drought-tolerant species. Areas outside of the immediate stream corridor may be used as irrigated park lands. The corridor will be used for low-impact human recreation and relaxation. The corridor will also accommodate wildlife movement and provide habitat. 	<ul style="list-style-type: none"> The native hillside zones are located on hillside slopes. The zones will be characterized by native or naturalized grasses and shrubs. Tree species appropriate for this landscape type may be used. Existing grasslands may be enhanced and/or restored to increase biodiversity and create wildlife habitat. The hillside zones may also be used for low-impact human recreation and relaxation. 	<ul style="list-style-type: none"> The transportation corridor zone is defined by the north/south transportation corridor right-of-way boundaries and the buffer lands between highway and the community. The corridor shall be predominantly planted with native or drought-tolerant plant species. Irrigated, ornamental plantings are allowed at entries to the community and at the base of bridge abutments. Plantings are intended to enhance aesthetics and to buffer surrounding uses from the highway. 	<ul style="list-style-type: none"> Parkways are wide open space corridors that are bounded by community streets. Parkways will be planted primarily with native or drought-tolerant plants. Irrigated, manicured active recreation areas and parks are allowed and encouraged. Parkways accommodate small game wildlife movement by linking habitat areas and enhance storm water management by retaining and detaining surface runoff in constructed wetlands. The community trail system utilizes parkways to link major open space components and urban centers. 	<ul style="list-style-type: none"> Regional parks will accommodate a variety of uses from active recreational playfields to passive recreational walking trails and picnic areas. Regional parks will serve the entire community. They will function as urban parks with associated playfields and activities. The landscape shall be primarily planted with irrigated, ornamental species in the active recreation areas including turf grasses and specimen trees. Passive recreation areas shall be primarily planted with non-irrigated native or drought-tolerant species except where irrigated areas are required for specific uses. Commercial uses such as vending and retail kiosks are allowed in regional parks. 	<ul style="list-style-type: none"> Neighborhood parks are 1 to 2-acre parks located throughout the community in neighborhood centers. Neighborhood parks may share parking, open space, and other common amenities with neighborhood schools and churches. Commercial uses such as vending and retail kiosks are allowed in neighborhood parks. 	<ul style="list-style-type: none"> Pocket parks are 1/3 to 1/2-acre parks located throughout the community in neighborhood centers. Pocket parks are organized around one or two distinct uses and provide relaxation and recreation opportunities for community residents. Pocket parks may be mostly urban with hard paving and trees in tree grates or may be irrigated gardens. Commercial uses such as vending and retail kiosks are allowed in pocket parks.
LOCATIONAL DIAGRAM	<ul style="list-style-type: none"> Diagrams are for illustrative purposes only. 							
LANDSCAPING	<ul style="list-style-type: none"> To develop a variety of landscape types that reflects the respective natural and cultural contexts of the development and is appropriate to environmental conditions. 	<ul style="list-style-type: none"> Riparian vegetation shall predominate near the existing stream bed if it can be supported by existing ground water conditions. The remainder of the riparian zone shall be predominately existing native plant materials. Native or drought-tolerant vegetation that is conducive to creating diverse wildlife habitat shall be used when revegetating disturbed areas within this zone. If ground water conditions allow, riparian trees such as willows or cottonwoods may be planted to enhance or restore the riparian character of the existing stream corridor. Areas outside of the direct stream bed may be used as irrigated parkland. Constructed wetlands, including open water areas, are allowed for the treatment and retention or detention of storm water. Native and drought-tolerant plants may require temporary irrigation in order to become established. 	<ul style="list-style-type: none"> Existing native grasses and shrubs shall predominate in the native hillside zones. Tree species adapted to local environmental conditions and slope aspects may be used on native hillside for wildlife habitat, visual screening, and landscape variety. Constructed wetlands, including open water areas, are allowed for the treatment and retention or detention of storm water. Irrigated ornamental landscape treatments are allowed where this zone meets community entry streets and should reflect the landscape character of the adjacent communities. Constructed water features, including open water areas, are allowed at these entry points. Native or drought-tolerant plants may require temporary irrigation in order to become established. 	<ul style="list-style-type: none"> Native or drought and salt-tolerant vegetation shall predominate along the transportation corridor. Tree species adapted to local environmental conditions and slope aspects may be used for small game wildlife habitat, visual screening, and landscape variety. Irrigated, ornamental landscape treatments are allowed at entries and intersections and should reflect the landscape character of the adjacent communities. Bridge abutments may be screened and softened with native or drought-tolerant vegetation or irrigated ornamental plantings. Native or drought-tolerant plants may require temporary irrigation in order to become established. 	<ul style="list-style-type: none"> Parkways may be used as vegetative windbreak spines. Vegetative windbreaks reduce wind velocities at ground level. Active recreation areas may include irrigated turf grass play areas and ornamental plantings. Street tree spacing shall be consistent within individual blocks. Shrubs and hedges in streetside planters shall not exceed 30" high. Constructed wetlands, including open water areas, are allowed for the treatment and retention or detention of storm water. Native or drought-tolerant plants may require temporary irrigation for establishment. 	<ul style="list-style-type: none"> Active recreation areas may be irrigated. Active recreation areas may include turf grasses and ornamental plantings. Passive recreation areas should be primarily non-irrigated native or drought tolerant species. Constructed wetlands, including open water areas, are allowed for the treatment and retention or detention of storm water. Regional parks may include large open water bodies constructed for fishing, light boating, and other recreational uses, excluding swimming. 	<ul style="list-style-type: none"> Neighborhood parks may include active or passive recreation areas of irrigated turf grasses and ornamental plantings. Landscape character should match scale and character of the neighborhood. Neighborhood parks should be combined with schoolyards wherever possible. Constructed wetlands, including open water areas, are allowed for the treatment and retention or detention of storm water. 	<ul style="list-style-type: none"> Pocket parks may include irrigated turf grasses and ornamental plantings. Landscape character should match scale and character of the neighborhood.
FENCING	<ul style="list-style-type: none"> To ensure fencing complements building types through the use of compatible materials of comparable quality, aesthetics, and durability. 	<ul style="list-style-type: none"> Fencing shall be visibly penetrable (screen fencing is exempt from this requirement). Fencing should not impede the movement of wildlife through the corridor. Fences may be used to screen undesirable views and/or adjacent land uses. Fencing used for screening may be opaque and may be as tall as necessary to perform its function. Fencing shall reflect the landscape character of this zone in materials, style, and color. Fencing should recede into the landscape and not be visually dominant. 	<ul style="list-style-type: none"> Fencing in this landscape type shall be visibly penetrable (screen fencing is exempt from this requirement). Fencing should not impede the movement of wildlife through the corridor. Fencing may be used in this zone to screen undesirable views and/or adjacent land uses. Fencing used as screens may be opaque and may be as tall as necessary to perform their function. Fencing shall reflect the landscape character of this zone in materials, style, and color. Fencing should recede into the landscape and not be visually dominant. 	<ul style="list-style-type: none"> Fencing shall reflect adjacent architectural character in material, style, and color including R.O.W. fencing and safety fencing. 	<ul style="list-style-type: none"> All service areas shall be screened with opaque fences or walls. Fences used as screens may be as tall as necessary to perform their function. Fences and walls shall match open space character in materials and style. No fencing in parkways is allowed other than service screening and safety fencing. 	<ul style="list-style-type: none"> All service areas shall be screened with opaque fences or walls. Fences used as screens may be as tall as necessary to perform their function. Fences and walls shall match community character in materials and style. Chainlink fencing is allowed only at active recreation ballfields for spectator safety. 	<ul style="list-style-type: none"> All service areas shall be screened with opaque fences or walls. Fences used as screens may be as tall as necessary to perform their function. Fences and walls shall match associated architecture in materials and style. No chainlink fencing is allowed around schoolyards. Chainlink fencing is allowed only at active recreation ballfields for spectator safety. 	<ul style="list-style-type: none"> All service areas shall be screened with opaque fences or walls. Fences used as screens may be as tall as necessary to perform their function. Fences and walls shall match associated architecture in materials and style.
LIGHTING	<ul style="list-style-type: none"> To ensure that lighting has a pedestrian-scaled ambiance, provides for public safety, minimizes light pollution, and protects the night sky. 	<ul style="list-style-type: none"> Lighting may occur only along trails and pathways for safety purposes. Only low-level lighting with cut-offs is allowed in the riparian/stream zone. Cut-offs protect adjacent uses from light source spillage and protect the night sky from light pollution. 	<ul style="list-style-type: none"> Lighting may occur only along trails or pathways for safety purposes. Only low-level lighting with cut-offs is allowed in these visually sensitive hillside zones. Cut-offs protect adjacent uses from light source spillage and protect the night sky from light pollution. 	<ul style="list-style-type: none"> Lighting located on bridge crossing should be similar to South Jordan City standards as of 2002 to provide street continuity between the two sides of the community. Highway lighting should employ cut-offs to minimize light pollution and focus light on the highway. Lighting standards should be similar in style and character to South Jordan City standards as of February 2002. 	<ul style="list-style-type: none"> Lighting style should be similar to South Jordan City standards as of February 2002. Only low-level lighting for pedestrian safety is allowed along internal pathways and trails. 	<ul style="list-style-type: none"> Only low-level pedestrian-scaled lighting is allowed along pathways/trails and at public facilities. Lighting fixtures shall reflect community character in materials, style, and color. Active playfields and courts may be lighted with shielded lighting to minimize off-site light pollution. 	<ul style="list-style-type: none"> Only low-level pedestrian-scaled lighting is allowed along pathways and trails and at public facilities. Lighting standards should be similar in style and character to South Jordan City standards as of February 2002. 	<ul style="list-style-type: none"> Lighting standards should be similar in style and character to South Jordan City standards as of February 2002.
OUTDOOR FURNITURE	<ul style="list-style-type: none"> To ensure outdoor furniture enhances the enjoyment of public spaces and complements its location through the use of compatible materials of similar quality and durability. 	<ul style="list-style-type: none"> Outdoor furniture shall reflect the landscape character of this zone in materials, style, and color. Outdoor furniture in irrigated parkland areas should match neighborhood park furniture. 	<ul style="list-style-type: none"> Outdoor furniture shall reflect open space or community character in materials, style, and color. 	<ul style="list-style-type: none"> Outdoor furniture shall reflect community character in materials, style, and color. Bridge railings should match community character. 	<ul style="list-style-type: none"> Outdoor furniture shall reflect community character in materials, style, and color. Bench seating shall be located at convenient locations along trails and at civic nodes. 	<ul style="list-style-type: none"> Outdoor furniture shall reflect community character in materials, style, and color. Bench seating shall be located at convenient locations along trails and at civic nodes. 	<ul style="list-style-type: none"> Outdoor furniture shall reflect community character in materials, style, and color. Bench seating shall be located at convenient locations along trails and at civic nodes. 	<ul style="list-style-type: none"> Outdoor furniture shall reflect community character in materials, style, and color.

NOTE
 The Kennecott Development Standards Matrix on Sheets 4 through 6 of this Kennecott Master Subdivision #1, are intended by the City of South Jordan and OM Enterprises Company, the owner of the land identified as Kennecott Master Subdivision #1 (as described in the Boundary Description included on Sheets 1 and 2 of this Master Subdivision Plat), to govern all future development, improvement or alterations of said land or improvements thereon, and to run with said land in perpetuity and be binding on existing and successive owners and interest holders of said land.

KENNECOTT MASTER SUBDIVISION #1
 A TRACT OF LAND SITUATED IN SECTIONS 18 AND 19, TOWNSHIP 3 SOUTH, RANGE 1 WEST, AND SECTIONS 13, 14, 15, 22, 23 AND 24, TOWNSHIP 3 SOUTH, RANGE 2 WEST, SALT LAKE BASE AND MERIDIAN SALT LAKE COUNTY, UTAH



SHEET NUMBER		5 OF 6	
SCALE		NA	
PROJECT NUMBER		A	
No.	Issue for South Jordan Signature	K/JW	5/03/02
	Revisions	By	Date

PLANNING COMMISSION
 APPROVED THIS 14TH DAY OF May A.D., 2002 BY THE SOUTH JORDAN CITY PLANNING COMMISSION.
 CHAIRMAN, SOUTH JORDAN PLANNING COMM.

HEALTH
 APPROVED AS TO FORM THIS 17TH DAY OF May A.D., 2002
 DIRECTOR, SALT LAKE CO. BOARD OF HEALTH

SOUTH JORDAN CITY ENGINEER
 I HEREBY CERTIFY THAT THIS OFFICE HAS EXAMINED THIS PLAT AND IT IS CORRECT IN ACCORDANCE WITH INFORMATION ON FILE IN THIS OFFICE.
 5/9/02
 SOUTH JORDAN CITY ENGINEER

APPROVAL AS TO FORM
 APPROVED AS TO FORM THIS 17TH DAY OF May A.D., 2002
 SOUTH JORDAN CITY ATTORNEY

SOUTH JORDAN CITY COUNCIL
 PRESENTED TO THE SOUTH JORDAN CITY COUNCIL THIS 16TH DAY OF April A.D., 2002, AT WHICH TIME THIS PLAT WAS APPROVED AND ACCEPTED.
 CITY RECORDER
 MAYOR, CITY OF SOUTH JORDAN

RECORDED # 837680
 STATE OF UTAH, COUNTY OF SALT LAKE, RECORDED AND FILED AT THE REQUEST OF: SOUTH JORDAN
 DATE: 04/20/02 TIME: 3:16pm BOOK: 2002 PAGE: 273
 \$20.00
 FEE\$
 CHIEF DEPUTY SALT LAKE COUNTY RECORDER

KENNECOTT DEVELOPMENT STANDARDS MATRIX

CIRCULATION SYSTEM

KENNECOTT MASTER SUBDIVISION #1

	INTENT	TOWN CENTER STREETS	BOULEVARDS	LOCAL STREETS	ALLEYS	TRAILS, WALKS, & BIKEWAYS	PARKING & ACCESS	TRAFFIC CALMING
PRINCIPLES	<ul style="list-style-type: none"> The circulation system is the overarching organizing system of the community. It is composed of a hierarchical network of differing street and trail types along with associated traffic calming devices and parking areas. The circulation system provides visual and physical continuity between land use areas. Landscape treatments of the circulation system range from native planting that reflect the community's context in a high desert to more refined irrigated treatments near centers. 	<ul style="list-style-type: none"> The public domain of town center streets is characterized by urban hardscape qualities and bounded by ground floor uses that are typically commercial - either retail or office. Trees are generally planted in tree grates in sidewalks and shrubs, flower, and other plants are located in planting containers such as pots, boxes, or raised seating planters. 	<ul style="list-style-type: none"> Boulevards are community streets that incorporate the use of planted medians to separate traffic flow direction and provide a pleasant driving experience. Medians on boulevards may be 20' or greater in width. 	<ul style="list-style-type: none"> Local streets form the primary vehicular and pedestrian system within neighborhoods. Local streets shall be planted with street trees. On-street parking is encouraged on local streets. 	<ul style="list-style-type: none"> Alleys are used to allow vehicular access to rear yards and garages and to accommodate city services such as garbage collection. 	<ul style="list-style-type: none"> The trail, walk, and bikeway system flows through all of the landscape types in the community. Trails and their associated furnishings shall meet the landscaping, fencing, lighting, and outdoor furniture requirements for each landscape type. 	<ul style="list-style-type: none"> Parking areas within the community shall be screened with landscaping, fencing, or both. Landscape treatments for parking areas should be compatible with the surrounding landscape type in order to fit as seamlessly as possible into the community structure. The intent of landscape and screening efforts is to minimize the visual presence of asphalt and cars and to reduce heat islands in the community. 	<ul style="list-style-type: none"> A variety of traffic calming and control devices may be employed in the community to slow traffic, increase pedestrian safety, and increase traffic flow efficiency. Traffic calming devices include traffic circles, bulb-outs, changes of pavement materials at pedestrian crossings, and raised intersections. Traffic control mechanisms may include roundabouts, couplets, signals, and signs.
LOCATIONAL DIAGRAM	<ul style="list-style-type: none"> Diagrams are for illustrative purposes only. 							
SECTIONAL DIAGRAM	<ul style="list-style-type: none"> Diagrams are for illustrative purposes only. 							
LANDSCAPING	<ul style="list-style-type: none"> To develop a variety of landscape types that reflects the respective natural and cultural contexts of the development and is appropriate to environmental conditions. 	<ul style="list-style-type: none"> Street tree spacing along town center streets shall be consistent within individual blocks. Street trees shall be located in tree grates and integrated into town center sidewalk systems. Shrubs, hedges, and grasses in street planters within 10' of the back of street curb shall not exceed 30" height in order to preserve visual connections from sidewalk to street. 	<ul style="list-style-type: none"> Medians shall be primarily planted with native or drought-tolerant vegetation. Active recreation areas may be located in boulevard medians and may be planted with irrigated turf grasses and ornamental species. Boulevards may be planted with tall tree species that can act as windbreaks. Street tree spacing shall be consistent within individual blocks. Tree lawns may be turf (irrigated), native or drought-tolerant grasses (non-irrigated), or low, durable groundcovers. Tree lawn landscape treatments shall be consistent within individual blocks. Constructed wetlands, including open water areas, are allowed in boulevard medians for the treatment and retention or detention of storm water. 	<ul style="list-style-type: none"> Street tree spacing along local streets shall be consistent within individual blocks. Tree lawns between sidewalk and street edge shall be turf (irrigated), native or drought-tolerant grasses (non-irrigated), or low, durable groundcovers. Tree lawn landscape treatments shall be consistent within individual blocks. 	<ul style="list-style-type: none"> Landscape plantings may be used to give visual relief to alleys. 	<ul style="list-style-type: none"> Bikeways located on-street shall meet AASHTO standards at time of construction. Tree plantings along bikeway alignments in open space areas must be set back from pavement edge a minimum of 4'. Trails and bikeways may be a combination of hard paving and soft paving to accommodate diverse user groups such as bikers and runners. Separate trails systems are allowed in open space areas for incompatible uses such as biking and horseback riding. A minimum 3' buffer is required between trail systems. Walking trails in natural areas may be as narrow as 4' and have a soft surface such as pea gravel, crusher fines, or bark mulch. 	<ul style="list-style-type: none"> Tree plantings shall be planted in a grid pattern to maximize shade, enhance the parking experience, and reduce the visual impact of the parking area. In areas where parking abuts a street, a minimum landscape buffer zone of 10' is required between the parking area and the parking area side of the street sidewalk. Buffer planting species shall match the surrounding landscape type. Bio-swales shall be used between parking rows where possible and planted with grasses and shrubs suited to storm water treatment. Small parking areas may be allowed for access to public trails and parks in the riparian/stream zone. On-street angled, perpendicular, and/or parallel parking is allowed on town center streets, boulevards, and local streets. On-street parking is prohibited in alleys. 	<ul style="list-style-type: none"> Bulb-outs at intersections and pedestrian crossings shall be planted with street trees. Trees shall be pruned to ensure driver visibility. Plantings in traffic calming areas may be native or drought-tolerant plants or irrigated ornamental plants. Planting types should reflect the surrounding landscape type. Shrub and grass plantings in traffic calming areas shall preserve driver visibility and maximize safety. Constructed wetlands for the treatment and retention or detention of storm water are allowed in traffic calming areas.
FENCING	<ul style="list-style-type: none"> To ensure fencing complements building types through the use of compatible materials of comparable quality, aesthetics, and durability. 	<ul style="list-style-type: none"> All service areas shall be screened from the public domain with opaque fences or walls. Fences used as screens may be as tall as necessary to perform their function. Fences and walls shall match associated architecture in materials and style. Sidewalk dining fences shall be visually non-obtrusive and shall not exceed 3' in height. 	<ul style="list-style-type: none"> Front yard and sideyard fencing on fee simple residential parcels shall not exceed 3' in height. Fencing shall reflect architectural character in materials, style, and color. Fencing for rear yard privacy may be up to 6' in height and may be of opaque construction. Rear yard privacy fencing that parallels boulevards shall be of consistent materials, color, height, and style for a minimum of four continuous blocks. No fencing in boulevard medians is allowed other than service screening and safety fencing. 	<ul style="list-style-type: none"> Front yard and sideyard fencing on individual residential parcels shall not exceed 3' in height. Fencing shall reflect architectural character in materials, style, and color. Fencing for rear yard privacy may be up to 6' in height and may be of opaque construction. Rear yard privacy fencing that parallels local streets shall be of consistent materials, color, height, and style within individual blocks. 	<ul style="list-style-type: none"> Fencing style shall match architectural character in materials, style, and color. Fencing for rear yard privacy may be up to 6' in height and may be of opaque construction. All service areas shall be screened from the public domain with opaque fences or walls. Fences used as screens may be as tall as necessary to perform their function. 	<ul style="list-style-type: none"> Any fencing located near trails shall be offset a minimum of 4' from the edge of trail pavement surface. Fencing style shall match requirements for the landscape typology where the trail is located. 	<ul style="list-style-type: none"> Fencing used to screen parking shall reflect the surrounding landscape type in materials, style, and color. 	<ul style="list-style-type: none"> No fencing shall be allowed in traffic calming areas.
LIGHTING	<ul style="list-style-type: none"> To ensure that lighting has a pedestrian-scaled ambience, provides for public safety, minimizes light pollution, and protects the night sky. 	<ul style="list-style-type: none"> Lighting standards should be similar in style and character to South Jordan City standards as of February 2002. Light levels to be conducive to pedestrian comfort and safety. 	<ul style="list-style-type: none"> Lighting standards should be similar in style and character to South Jordan City standards as of February 2002. Only low-level lighting for pedestrian safety is allowed along pathway and trail alignments within boulevard medians. 	<ul style="list-style-type: none"> Lighting standards should be similar in style and character to South Jordan City standards as of February 2002. 	<ul style="list-style-type: none"> Only low level lighting for pedestrian safety and property security is allowed in alleys. 	<ul style="list-style-type: none"> Lighting style shall match requirements for the landscape typology where the trail is located. Only low-level lighting for pedestrian safety is allowed along pathways and trails. 	<ul style="list-style-type: none"> Lighting standards should be similar in style and character to South Jordan City standards as of February 2002. 	<ul style="list-style-type: none"> Lighting standards should be similar in style and character to South Jordan City standards as of February 2002. Accent lighting may be used at traffic calming areas to ensure pedestrian safety.
OUTDOOR FURNITURE	<ul style="list-style-type: none"> To ensure outdoor furniture enhances the enjoyment of public spaces and complements its location through the use of compatible materials of similar quality and durability. 	<ul style="list-style-type: none"> Transit stops (light rail and bus) shall reflect the community architectural character and be the same throughout the entire community in order to establish their identity and legibility. Outdoor furniture shall reflect community character in materials, style, and color. 	<ul style="list-style-type: none"> Transit stops (light rail and bus) shall reflect the community architectural character and be the same throughout the entire community in order to establish their identity and legibility. Outdoor furniture shall reflect community character in materials, style, and color. 	<ul style="list-style-type: none"> Outdoor furniture shall reflect community character in materials, style, and color. 		<ul style="list-style-type: none"> Bench seating shall be located along trails and at civic nodes. Furniture style shall match requirements for the landscape typology where the trail is located. 	<ul style="list-style-type: none"> Outdoor furniture shall reflect community character in materials, style, and color. 	<ul style="list-style-type: none"> Outdoor furniture shall reflect community character in materials, style, and color.

NOTE The Kennecott Development Standards Matrix on Sheets 4 through 6 of this Kennecott Master Subdivision #1, are intended by the City of South Jordan and OM Enterprises Company, the owner of the land identified as Kennecott Master Subdivision #1 (as described in the Boundary Description included on Sheets 1 and 2 of this Master Subdivision Plat), to govern all future development, improvement or alterations of said land or improvements thereon, and to run with said land in perpetuity and be binding on existing and successive owners and interest holders of said land.

KENNECOTT MASTER SUBDIVISION #1
 A TRACT OF LAND SITUATED IN SECTIONS 18 AND 19, TOWNSHIP 3 SOUTH, RANGE 1 WEST, AND SECTIONS 13 14, 15, 22, 23 AND 24, TOWNSHIP 3 SOUTH, RANGE 2 WEST, SALT LAKE BASE AND MERIDIAN SALT LAKE COUNTY, UTAH

RECORDED # 8316820

STATE OF UTAH, COUNTY OF SALT LAKE, RECORDED AND FILED AT THE REQUEST OF: South Jordan

DATE: 04/20/02 TIME: 3:16pm BOOK: 2002 PAGE: 213
 \$201.00 FEE\$ James Reddy CHIEF DEPUTY SALT LAKE COUNTY RECORDER

DESIGN WEST
 DESIGN WORKSHOP
 Landscape Architecture • Land Planning • Urban Design • Tourism Planning

SHEET NUMBER	6 OF 6
SCALE	NA
PROJECT NUMBER	
A Issue for South Jordan Signature	K/W 5/03/02
No. Revisions	By Date

PLANNING COMMISSION

APPROVED THIS 14th DAY OF May A.D., 2002 BY THE

[Signature]
 CHAIRMAN, SOUTH JORDAN PLANNING COMM.

HEALTH

APPROVED AS TO FORM THIS DAY OF May A.D., 2002

[Signature]
 DIRECTOR, SALT LAKE CO. BOARD OF HEALTH

SOUTH JORDAN CITY ENGINEER

I HEREBY CERTIFY THAT THIS OFFICE HAS EXAMINED THIS PLAT AND IT IS CORRECT IN ACCORDANCE WITH INFORMATION ON FILE IN THIS OFFICE.

5/9/02 [Signature]
 DATE SOUTH JORDAN CITY ENGINEER

APPROVAL AS TO FORM

APPROVED AS TO FORM THIS 17th DAY OF May A.D., 2002

[Signature]
 SOUTH JORDAN CITY ATTORNEY

SOUTH JORDAN CITY COUNCIL

PRESENTED TO THE SOUTH JORDAN CITY COUNCIL THIS 10th DAY OF April A.D. 2002, AT WHICH TIME THIS PLAT WAS APPROVED AND ACCEPTED.

[Signature] [Signature]
 CITY RECORDER MAYOR, CITY OF SOUTH JORDAN